

Katie Ritter

Advisor: Dr. Ali Memari

Structural Option

May 1, 2009

# DEVELOPING A PROTOTYPE

FINAL REPORT

*Executive* Residence Inn By Marriott

Norfolk, Virginia



# KATIE RITTER

## ARCHITECTURE

- Designed specifically to accommodate needs of extended-stay guests
- 160 suites (Studio, 1BR, 2 BR)
  - Separate living and sleeping areas
  - Full bath with each bedroom
  - Fully-equipped kitchenette
- First floor amenities:
  - Indoor pool/spa
  - Fitness room
  - Hearth room with 2-sided fireplace, study areas
  - Private meeting room
  - Guest laundry
- Attractive combination of contrasting exterior wall systems:
  - Drainable EIFS
  - Architectural Precast
  - Curtain wall (spandrel & vision)
- Single-ply EPDM roof, tapered insulation



## PROJECT STAFF

Owner LTD Management Co.  
Architect Jonathan Nehmer + Assoc.  
CM Clancy + Theys Construction  
SE Holbert Apple Assoc.  
CE Kimley-Horn & Assoc.  
MEP Karpinski Engineering



## Residence Inn by Marriott

Location **Downtown Norfolk, Virginia**  
Size **130,000 SF • 9 Stories**  
Cost **\$22 Million**  
Delivery **CM at Risk • January 2009**

## STRUCTURAL SYSTEMS

- 12" square precast pre-stressed concrete pile foundations
- Grade beams & 5" slab-on-grade
- 8" 2-way flat plate floor system, max span of 22'
- 1'-0" to 1'-2" reinforced concrete shear walls
- Transfer girders utilized to discontinue upper level columns, thereby creating large open spaces on first floor
- Steel canopies supported by hanger rods & moment connections

## MECHANICAL/ELECTRICAL/LIGHTING

- All-refrigerant system; 3 rooftop condensing units supply refrigerant to fan coil units in each guest room
- Single zone on 1<sup>st</sup> floor; 3 zones each of the upper floors
- Variable speed air-cooled condensers serve each zone
- 4,000 amp service, 480/277V, 3 phase, 4 wire electrical system
- 350 kW emergency standby generator
- Lighting fixtures mostly fluorescent/compact fluorescent
- Specialized guest room lighting includes xenon under-cabinet lighting in kitchenettes /halogen recessed lighting at headboards
- Wet service wall-mounted metal halide fixtures in pool area

## CONSTRUCTION

- Fast-track 1 year construction schedule – Jan 2008 to Jan 2009
- Challenging site – surrounded by heavily-traveled roads
- Innovative material storage solutions during construction

<http://www.engr.psu.edu/ae/thesis/portfolios/2009/kmr278/>

The Pennsylvania State University  
Architectural Engineering



**STRUCTURAL** OPTION

# TABLE OF CONTENTS

<b>ACKNOWLEDGEMENTS</b>	<b>5</b>
<b>EXECUTIVE SUMMARY</b>	<b>6</b>
<b>BUILDING OVERVIEW – ORIGINAL DESIGN</b>	<b>9</b>
SITE & ARCHITECTURE	9
EXTERIOR WALL SYSTEMS	13
ROOF SYSTEM	16
LIGHTING SYSTEMS	16
ELECTRICAL SYSTEMS	17
MECHANICAL SYSTEMS	17
<u>STRUCTURAL SYSTEMS</u>	19
SOILS & FOUNDATIONS	19
GRAVITY FORCE RESISTING SYSTEMS	21
LATERAL FORCE RESISTING SYSTEMS	23
<b>PROBLEM STATEMENT</b>	<b>25</b>
SUMMARY OF GOALS	26
<b>ARCHITECTURAL BREADTH</b>	<b>27</b>
<b>LIGHTING BREADTH</b>	<b>33</b>
<b>STRUCTURAL DEPTHS</b>	<b>35</b>
APPLICABLE CODES / REFERENCED STANDARDS	35
LOAD COMBINATIONS	35
<u>GRAVITY SYSTEMS</u>	36
REVISED GRAVITY LOADS	36
COLUMN RE-DESIGN	37
GRAVITY SYSTEMS CONCLUSIONS	42
<u>LATERAL SYSTEMS</u>	43
WIND LOADING CRITERIA	43
SEISMIC LOADING CRITERIA	46
ETABS MODEL – OVERVIEW OF ASSUMPTIONS	47
*MAE ACKNOWLEDGEMENT – COMPUTER MODELING*	48
SEISMIC LOADS – EQUIVALENT LATERAL FORCES	48
TORSION – INHERENT & ACCIDENTAL	50
STRUCTURAL IRREGULARITIES	51
RELATIVE STIFFNESS OF SHEAR WALLS	54
DESIGN LOADS ON SHEAR WALLS FOR RE-DESIGN	55
SHEAR WALL RE-DESIGN	57
OVERTURNING MOMENT & FOUNDATIONS	61

DRIFT / DEFLECTION CHECK	61
PROTOTYPE EVALUATION	62
LATERAL SYSTEMS CONCLUSIONS	63
<b>APPENDIX A : ARCHITECTURAL BREADTH</b>	<b>64</b>
CODE ANALYSIS	64
GREENGRID® SPECIFICATION	66
<b>APPENDIX B : LIGHTING BREADTH</b>	<b>67</b>
LUMEN METHOD CALCULATIONS	67
LUMINAIRE SELECTION SPEC. & PHOTOMETRIC REPORT	69
BALLAST SELECTION SPEC.	75
<b>APPENDIX C : GRAVITY SYSTEMS</b>	<b>76</b>
SLAB THICKNESS CHECK	76
COLUMN UNBALANCED MOMENTS CALCULATIONS	78
PCA COLUMN – 11 STORY RE-DESIGN RESULTS	83
PCA COLUMN – 9 STORY ORIGINAL DESIGN RESULTS	91
<b>APPENDIX D : LATERAL SYSTEMS</b>	<b>97</b>
SEISMIC WEIGHT CALCULATION	97
SEISMIC LOAD CALCULATION ASSUMPTIONS & FACTORS	104
STRUCTURAL IRREGULARITY CHECKS	106
SHEAR WALL RE-DESIGN CALCULATIONS	109
SHEAR WALL RE-DESIGN COST ANALYSIS	128

## ACKNOWLEDGEMENTS

Many thanks to all of those individuals and firms who were vital to the success of this thesis project:



Holbert Apple Associates, Inc.  
Structural Engineers

David Holbert  
Rich Apple  
Sante Taroli



LTD Management Co., LLC.  
Hotel Development & Management Group

Bharat Shah



Clancy + Theys Construction Company  
Construction Manager

JD Borrero



Jonathan Nehmer + Associates, Inc.  
Architect

Warren Feldman



The Pennsylvania State University  
AE Faculty & Staff

Dr. Ali Memari  
Dr. Andres Lepage  
M. Kevin Parfitt  
Robert Holland



Family & Friends  
For their unwavering support & motivation

Jason  
Mom & Mike  
Daddio  
AE Colleagues

## **EXECUTIVE SUMMARY**

The original nine story hotel, the Residence Inn, located in downtown Norfolk, VA, features 160 luxurious suites, designed to accommodate the needs of the extended-stay guest. Each suite features separate living, sleeping, and food preparation areas, complete with fully-equipped kitchenettes. The hotel recently opened after being constructed over the past year, for a total cost of approximately \$22 million.

Structural systems of the building as originally designed include structural reinforced cast-in-place two-way slabs, columns, and shear walls, all eventually resting on grade beams and precast concrete piles at the foundation.

One of the goals of this thesis was to create a new signature brand for Marriott specifically designed to accommodate the needs of the business traveler, adding an office-suite dimension to hotel-style living. The idea of this mixed-use building is to ease the burden for the traveling professional by providing separate residence and office suites, thus enabling them to conduct business conveniently and in a professional manner, while maintaining a sense of personal life and pleasure. Architectural plans and 3-D renderings were developed to illustrate the intentions of the design and its interface with the hotel below. In the process of meeting this goal, green roof spaces were also designed and a signature lighting scheme for the shared conference rooms was created.

Due to the confined nature of many sites, including this one, the only plausible solution to an expansion is vertically. Therefore, the additional load created by the two story expansion required that gravity columns be re-designed accordingly.

With the introduction of just two additional floors projecting vertically from the originally designed structure, corresponding to a 22% increase in overall building size, lower level column sizes were found to increase on average by 30%. This result indicates a diminishing return on gravity structural systems. Perhaps a more economical solution would have been to expand the footprint of the building to accommodate the additional program requirements; however, for this particular site, this would not have been a feasible alternative. Almost all column designs were governed by slenderness, or a tendency for the columns to buckle due to unbraced lengths between stories. Small increases in unbraced lengths with similar axial loads were noted to have a tremendous impact on the strength of the column to

resist buckling. Moments induced in the columns due to drift were found to be most significant at the lower stories, due to the increased affect with larger axial loads found there. In general, the results were as expected: increased column sizes to resist larger gravity loads.

In addition, a second goal was identified to gain experience in seismic design of building structures. Since Marriott's network of lodging is so expansive and constantly growing, it would be beneficial to have a prototypical structure that could be used in a number of different locations throughout the United States. This would reduce the amount of re-engineering required of similar buildings. The current location of the Residence Inn by Marriott is downtown Norfolk, Virginia, where seismic activity is relatively low. In order to develop a prototype for the structural systems for more locations across the United States, the structure would need to be designed for additional seismic loads. Increased mapped spectral response acceleration parameters of 50% and 15% of gravity for the short and long period accelerations respectively and a more severe Seismic Design Category D were used as criteria for the design to ensure that the structure is capable of being located in the most locations. Wind pressures are already relatively high in this region, but were increased to be applicable for more coastal regions.

After the new lateral loading criterion was developed, the building was analyzed and lateral resisting shear walls were re-designed to meet the new demands. Extensive use of the computer modeling program ETABS was used for this portion in order to satisfy the MAE requirement. A number of assumptions were necessary to proceed with the designs, which are discussed further in the report.

Based on the analysis, it was found that Special Reinforced Concrete Shear Walls were required by code, as opposed to the Ordinary Reinforced Concrete Shear Walls of the original design. The results of the shear wall re-design indicate that in general, special reinforced concrete shear walls require a special boundary element design, which, in many cases, causes a significant increase in material, particularly reinforcement. Although architecturally the re-design had little effect, the hidden increase in strength and ductility directly correlated with an increase in cost of structural systems of approximately 2.1% or \$91,500 for this design in Norfolk, VA. Assuming that structural engineering costs are reduced by two thirds by taking advantage of a design that is, for the most part, 'pre-engineered,' it is estimated that for each new reproduction of the prototype, a savings of \$11,500 could be realized. For obvious

reasons, some structural engineering would be required that takes into consideration the particular site for which the prototype would be located for design of foundations and checks for more critical conditions than were assumed by the prototype. Since the cost savings realized would be small relative to the total cost of the building (\$22 million in Norfolk, VA), moral consideration must play a role in the decision of whether or not to consider using the 'over-designed' prototype for less critical locations, as there is a significant associated increase in the use of non-renewable resources and energy to produce the excess steel reinforcement. Otherwise, this exercise proved to be a valuable one, where experience in shear wall design for high seismic loading was obtained. The possibility of a prototype structure for the *Executive Residence Inn* remains and would certainly be valuable to a company such as Marriott, to whom economy could be realized, especially after a number of reproductions.



## BUILDING OVERVIEW – ORIGINAL DESIGN



(FIGURE 1) Residence Inn Perspective & Interiors - Original Design

### SITE & ARCHITECTURE

The new Residence Inn by Marriott is situated in a lively downtown Norfolk, Virginia area, surrounded on all sides by busy streets. The hotel has recently opened its doors as an upscale temporary residence with extensive amenities for its extended stay patrons. The building itself boasts a unique combination of simple structural components and fascinating architectural features. A tasteful combination of architectural precast, drainable Exterior Insulation Finishing System (EIFS), and curtain wall is used to make this building an impressive and distinguished landmark in the community.

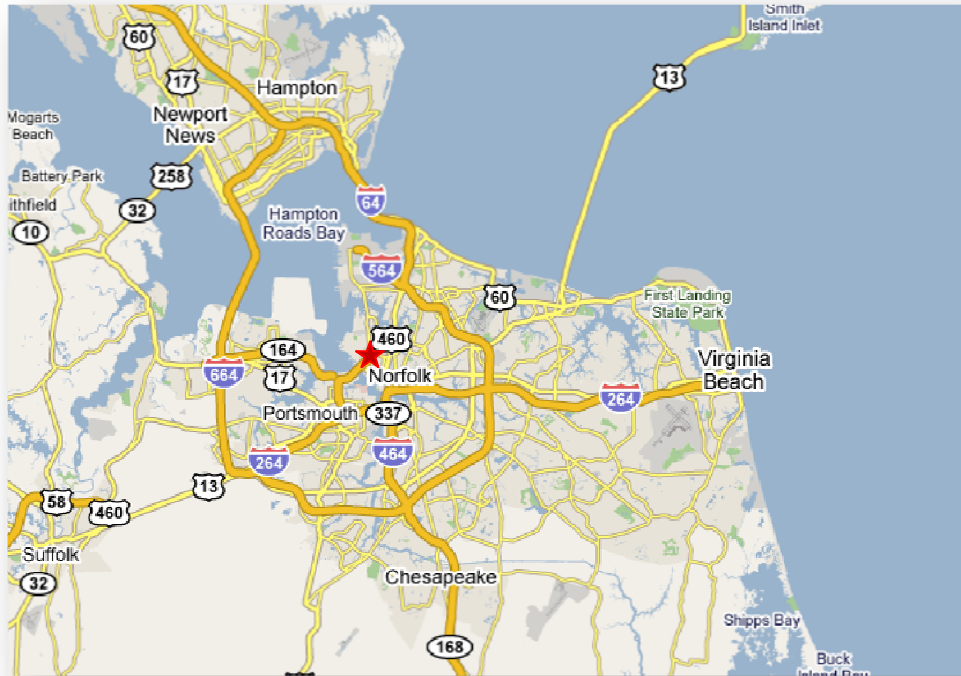

(FIGURE 2) Site Location Map – City & Surrounding Areas

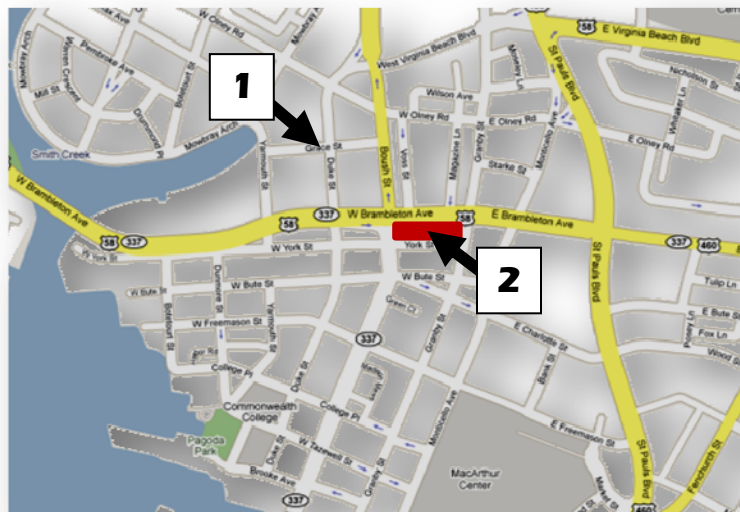

(FIGURE 3) Site Location Map – Street Level



(FIGURE 4) Aerial View from NW Looking SE



(FIGURE 5) View from Site - SE Looking NW

There are 160 guest suites on eight upper floors, with public functions, such as lobbies, gathering areas, and an indoor swimming pool, located on the first floor. The extensive program on the first floor requires large open spaces desired for architectural allure. The upper floors generally have the same layout; only minor differences exist to accommodate various room types. A main corridor connecting the emergency stairwells at either end of the building separates ten guest suites each on the North and South sides of the building. A pair of elevators is located at a central core along this corridor. Each guest suite features separate living and sleeping areas, as well as a fully-equipped kitchenette. Many of the upper floor suites have magnificent views of the surrounding city and inner-coastal bays.

Typical floor-to-floor heights are 9'-4", with the first floor having a height of 19'-0". The total height of the building as designed is approximately 95 feet, excluding parapets and stair towers that extend beyond the main roof. Floor plans illustrating the architecture and general configuration of the original building are shown below in Figures 6 & 7.

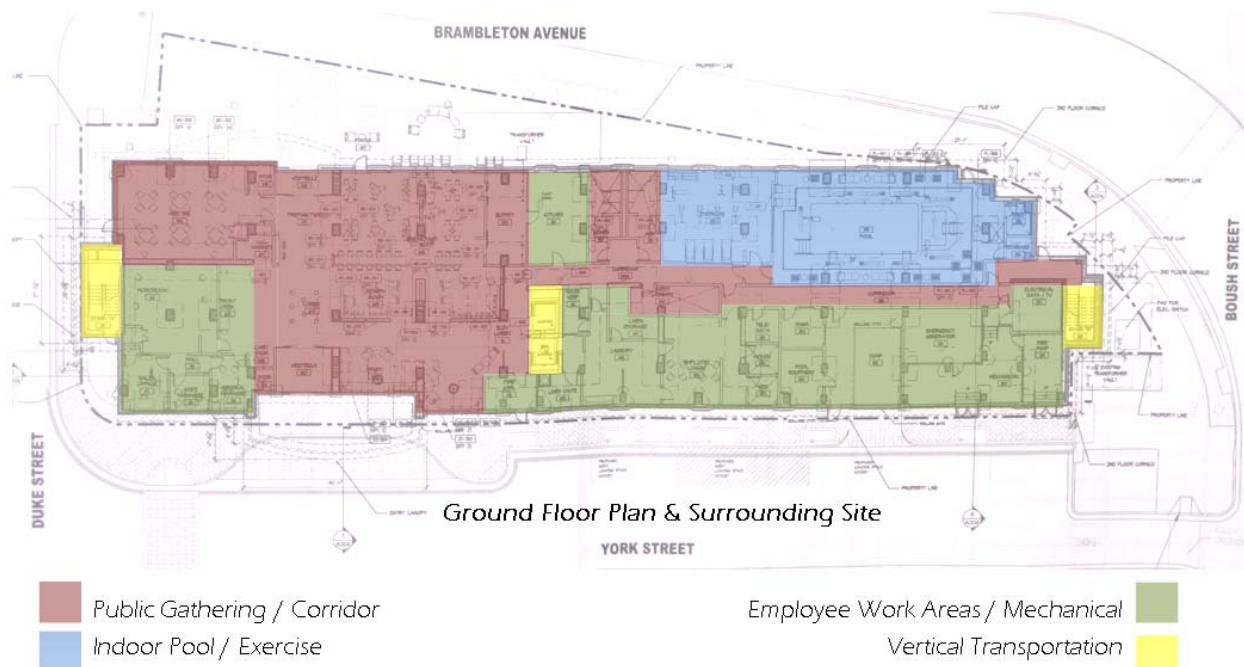

(FIGURE 6) Ground Floor Plan – Original Design



- |   |   |
|---|---|
| <span style="display: inline-block; width: 15px; height: 15px; background-color: #e67e22; border: 1px solid black; margin-right: 5px;"></span> Guest Suites | <span style="display: inline-block; width: 15px; height: 15px; background-color: #8e9e90; border: 1px solid black; margin-right: 5px;"></span> Employee Work Areas / Mechanical |
| <b>S</b> Studio   | <span style="display: inline-block; width: 15px; height: 15px; background-color: #ffff00; border: 1px solid black; margin-right: 5px;"></span> Vertical Transportation          |
| <b>1</b> 1-Bedroom  | <span style="display: inline-block; width: 15px; height: 15px; background-color: #c0c0c0; border: 1px solid black; margin-right: 5px;"></span> Corridor                         |
| <b>2</b> 2-Bedroom  |   |

(FIGURE 7) Typical Upper Floor Plan

## EXTERIOR WALL SYSTEMS

Several different wall systems are utilized in the building, which gives architectural interest and is helpful in ‘breaking’ up sizeable facades. The first floor exterior walls feature a combination of both Architectural Precast and a 3” Drainable Exterior Insulation and Finish System, otherwise known as Drainable EIFS. Multiple shades of each are used to accent the various focal points. These wall finishing systems are supported by an 8” metal stud wall (studs @16” o.c.) with R-21 batt insulation faced with a 5/8” layer of moisture-resistant exterior sheathing. On the most publicly viewed façade, along Brambleton Avenue, is an intermittent glazed curtain wall system with an aluminum frame containing insulated vision and spandrel glass. Storefront Glazing systems are used for both lobby entrances. There are several punched windows located in the less conspicuous areas. The mechanical areas including the mezzanine level on the first floor also use architectural aluminum louvers for proper ventilation. The first floor, at approximately 20’ in height, is ‘crowned’ with a band of contrasting EIFS, distinguishing it from the guest floors above.

Floors 2 through 7 consists of a 6” metal stud wall (studs @16” o.c.) with sound-attenuating batt insulation and a similar Drainable EIFS configuration as described above. A series of operable punched windows provides natural daylight and ventilation for both living

and sleeping areas within the guest suites.

Floors 8 and 9 are pronounced by a continuous Glazed Curtain Wall system with an aluminum frame containing both insulated vision and spandrel glass. A 'crown' of EIFS, similar to that between the first and second floors, trims the top of the building for a nice finished look. This system is also employed to conceal any rooftop mechanical equipment.

Emergency stairwells at the East and West ends of the building consist of reinforced concrete walls with a 3 5/8" metal stud wall, 5/8" layer of moisture-resistant exterior sheathing, and a self-healing air and moisture barrier. The exterior of the stairwells are finished with a combination of the three systems described above: Architectural Precast, Drainable EIFS, and a Glazed Curtain Wall.

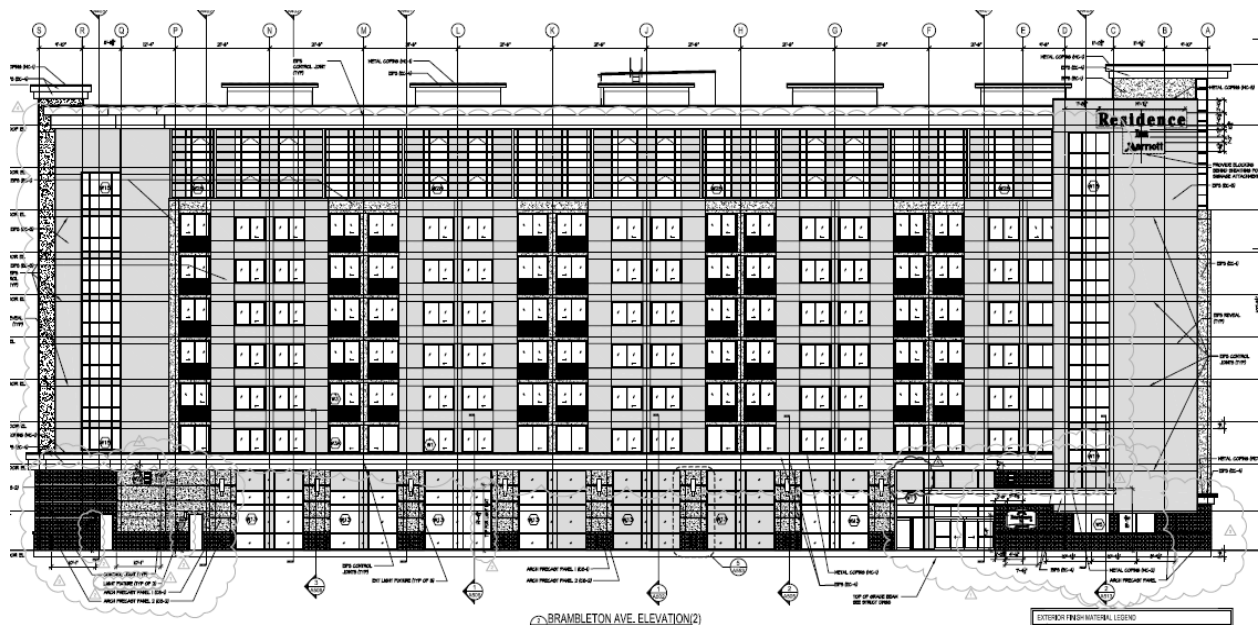

(FIGURE 8) Brambleton Ave. (North) Elevation

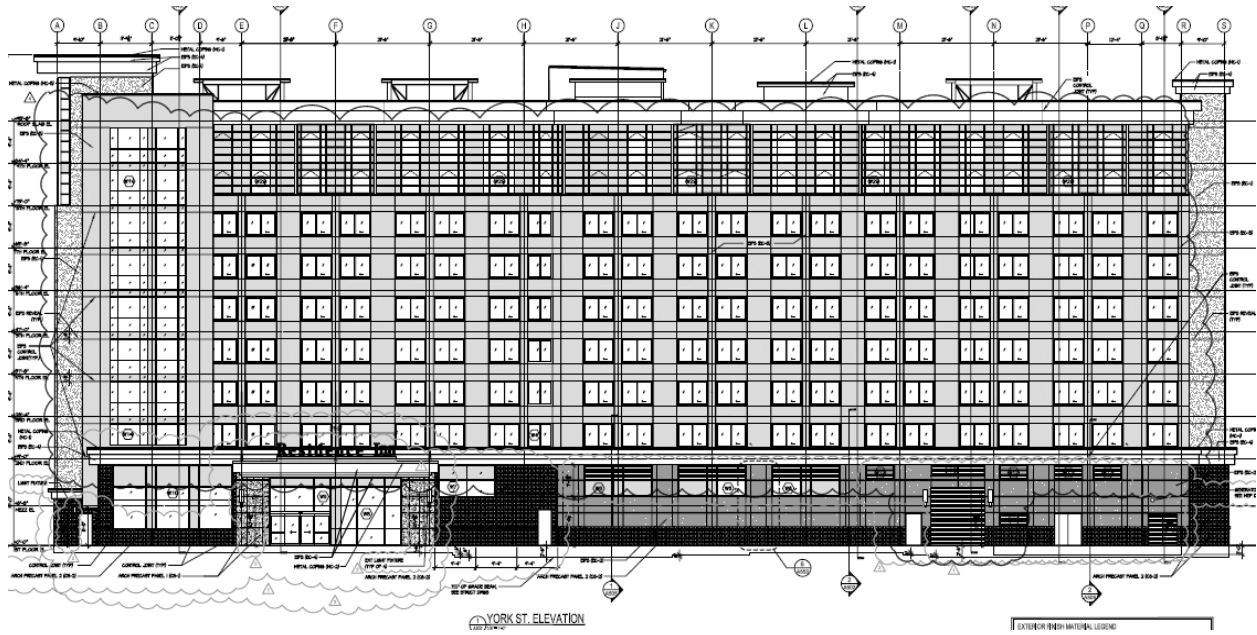

(FIGURE 9) York St. (South) Elevation

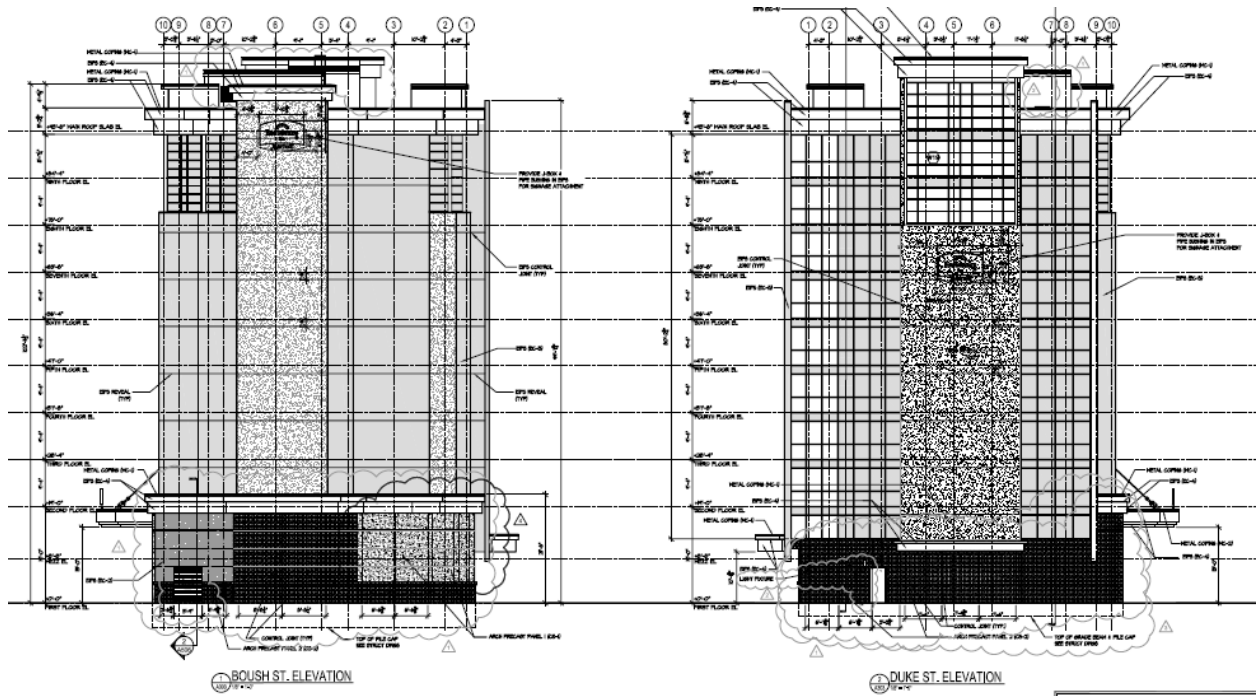

(FIGURE 10) Boush St. (East) & Duke St. (West) Elevations

## ROOF SYSTEM

The main roof employs a Single-Ply EPDM system, which consists of a 4" layer of tapered rigid insulation fastened directly to the concrete roof slab below, and a rubber-like membrane material adhered to the insulation. A series of roof drains and downspouts provide the necessary drainage of accumulated water. Where necessary for access to mechanical systems, plaza deck pavers are utilized and serve as the wear course. The canopies also employ this roofing system, the only difference being that they attach to metal roof deck below. This type of roofing systems is one of the most economical choices for simple flat-roof structures.

## LIGHTING SYSTEMS

The majority of the lighting fixtures throughout the Residence Inn by Marriott are either fluorescent or compact fluorescent. Guest suites feature compact fluorescent wall sconces and down lights, fluorescent pendant lighting in the dining area, ceiling-mounted compact fluorescents in the kitchenette and bathroom, and fluorescent vanity lighting. Specialized guest suite lighting includes xenon under-cabinet lighting in the kitchenettes, and recessed halogens over the headboards, as well as select areas in the kitchenettes. See renderings in Figure 11 below. All guest suite fixtures are 120 V.



(FIGURE 11) Interior Renderings – Original Design



## ELECTRICAL SYSTEMS

Electrical service to the building consists of 4,000 amp service at 480/277V, 3-phase and 4 wires at the main distribution panel. Directly off this panel are exterior lighting, mechanical units, emergency lighting, and the elevators.

In the event of an emergency, there is a 350 kW emergency standby generator, located on the first floor, which provides power to the necessary life safety equipment, including emergency lighting, the fire pump, and elevators. Automatic transfer switches are used to run these systems off the generator when necessary. 45 KVA and 15 KVA step-down transformers provide operational receptacles during both normal use and emergency situations.

A 2,000 KVA step-down transformer converts the primary voltage of 480/277V to 208/120V. There are two additional sub-distribution panels: one serving the guest floors, and the other serving the mechanical equipment on the roof. One sub-distribution panel has a 5,000 amp bus, serving a 2,000 amp bus duct to the guest floors, which serves two panel boards per floor at 400 amps each: one for lighting, and another for power, and is terminated at the ninth floor. The 5,000 amp bus also distributes power to panels and mechanical units at the first floor. The other sub-distribution panel branches off of the first and has a 1,200 amp bus with main lugs only serving rooftop mechanical units.

## MECHANICAL SYSTEMS

The Residence Inn by Marriott must accommodate the individualized heating and cooling needs of its guests. Both heating and cooling is achieved by an all-refrigerant mechanical system. Each of the guest room floors (floors 2-9) has three zones, each of which is supplied refrigerant from a variable refrigerant volume (VRV), variable-speed air-cooled condenser on the roof (Figure 12). These condensers each have a cooling and heating capacity of 96,000 BTU/h and 108,000 BTU/h respectively. Individual guest suites house vertical air handling units (either 400 cfm or 600 cfm, depending on the size of the suite) that then distribute conditioned air to the individual spaces within each suite.

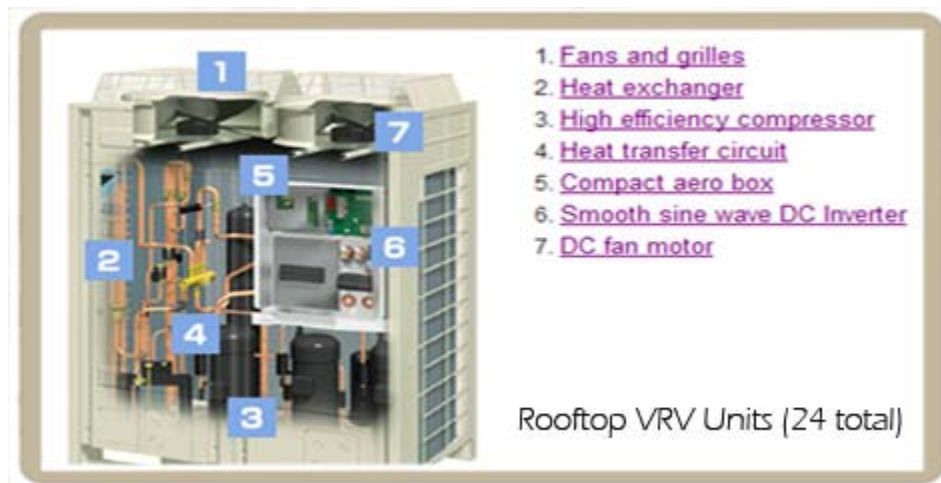

(FIGURE 12) Rooftop VRV Unit Diagram

Two rooftop direct expansion (DX) cooling and two-stage gas heat units, located on the roof at either end of the building supply the necessary outdoor air to each guest suite, as well as conditioned air to the corridors. The main tree runs vertically through a mechanical shaft, and branches out to the corridors on each floor. These units are fueled by natural gas and feature backward-inclined plenum blowers for energy efficient delivery of approximately 5,000 cfm of airflow.

The majority of the first floor and the elevator lobbies on each floor are conditioned by a 35-ton rooftop air conditioning unit located centrally on the roof. Variable air volume (VAV) terminal units or boxes with reheat coils branch off of the main supply and are located throughout the first floor, serving the individual needs of each space.

The indoor pool on the first floor requires a special ventilation unit to remove excess moisture from the air and provide air conditioning to the space as needed. This unit utilizes recycled energy from the moisture removal process to heat the pool water. An outdoor air-cooled condenser with a capacity of 470 BTU/h supplies this ventilation unit with refrigerant to cool the air (Figure 13).

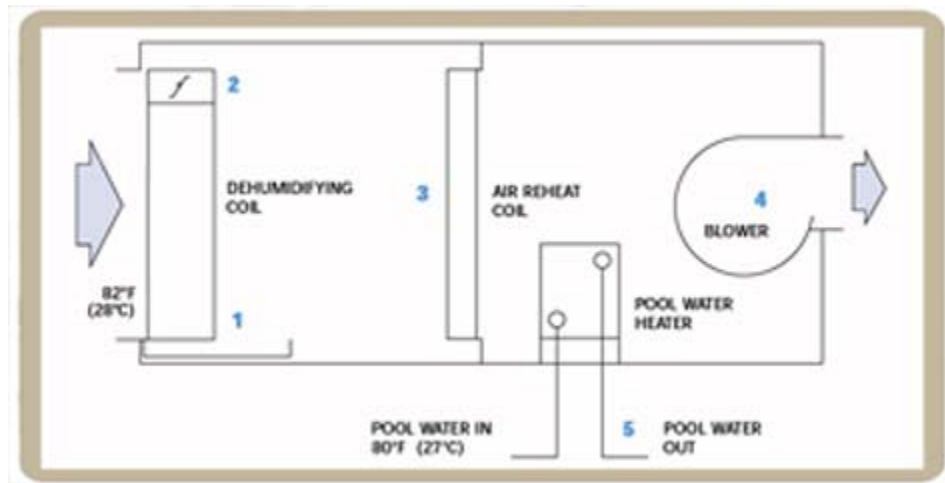

(FIGURE 13) Indoor Pool Mechanical System Diagram

## STRUCTURAL SYSTEMS

### SOILS & FOUNDATIONS

Located in a coastal area, the Residence Inn site requires special attention to its foundation systems. Friction piles are necessary because of the high water table and lack of a firm bearing stratum. Due to the highly compressible soils found at the site by the geotechnical engineer, McCallum Testing Laboratories, the hotel utilizes high capacity (100 ton) 12" square precast, pre-stressed concrete piles, driven to depths between 60' and 70' (Figure 14). All piles are capable of resisting 5,000 psi in compression and up to 35 tons of uplift. Tendons are to be subjected to 700 psi of prestress. Clusters of piles are joined together by reinforced concrete pile caps ( $f'_c=4,000\text{psi}$ ), the largest of which are located in areas supporting shear walls above (Figures 15 & 16). Depths of pile caps range from 1'-4" at a perimeter column over 3 piles to 5'-8" over 46 tension piles at the shear walls near the elevator core at the center of the building.

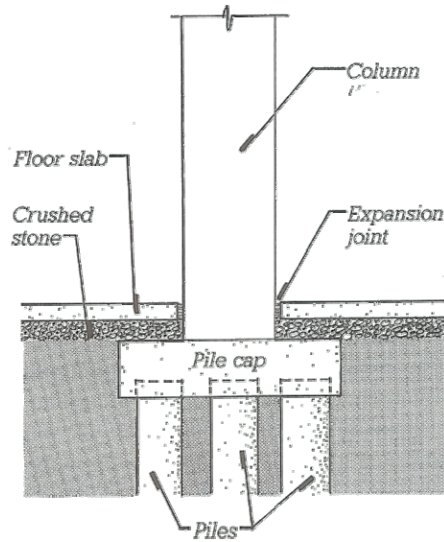

(FIGURE 14) Foundation System: Concrete Piles & Pile Caps

A continuous reinforced concrete grade beam ( $f'_c=4,000\text{psi}$ ) ranging in size from 24"x24" to 24"x40" is utilized around the perimeter of the building to transfer loads from the walls into the piles (Figure 2). A 5" concrete slab on grade ( $f'_c=3,500\text{psi}$ ) with 6x6-W2.1xW2.1 welded wire fabric is typical of the first floor, except where additional support is required for mechanical and service areas. Here, an 8" concrete slab on grade ( $f'_c=3,500\text{psi}$ ) with #4@12" o.c. each way, top and bottom, is required.

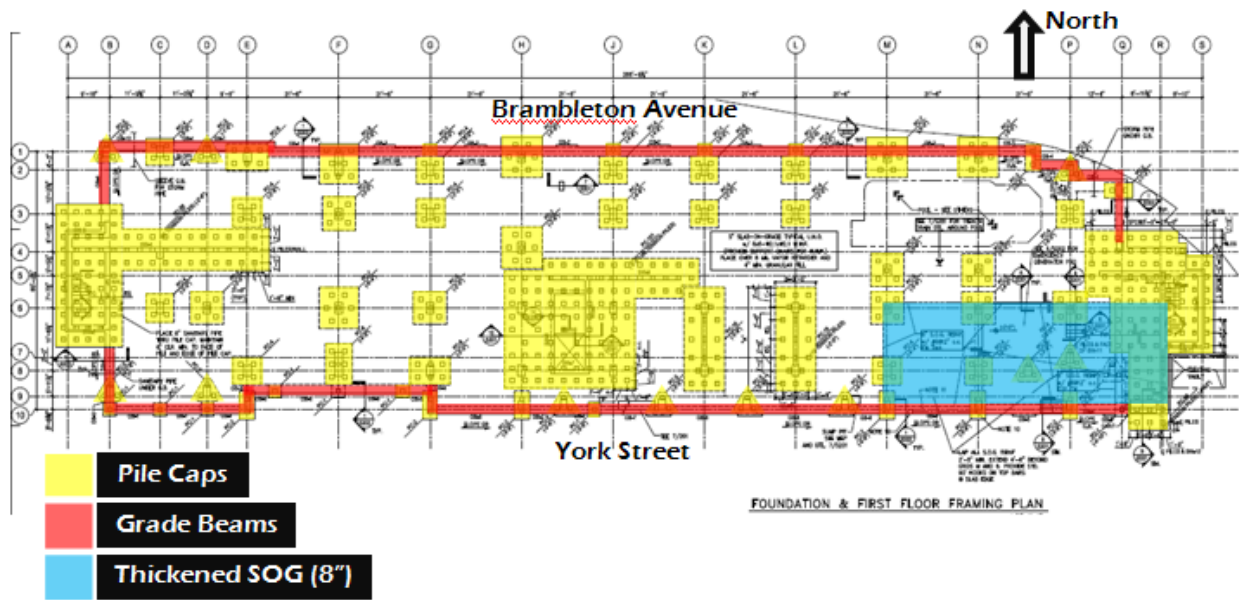

(FIGURE 15) Foundation & First Floor Framing Plan



(FIGURE 16) Foundations & 1<sup>st</sup> Floor Columns under Construction

## GRAVITY FORCE RESISTING SYSTEMS

Above grade, the Residence Inn is almost entirely structurally supported by reinforced concrete elements. The floor system as well as the roof consists of an economical 8" two-way flat plate slab, with a typical bay spacing of 21'-6". At the lower levels (third floor and below) 5,000 psi concrete is used for all slabs, beams, and columns; whereas, 4,000 psi concrete is reserved for use on the upper levels (fourth floor to the roof) primarily to maintain similar column sizes under differing loads. Typical slab reinforcement consists of a bottom mat of #4@12" o.c. everywhere, and top reinforcement varies based on location. Reinforced concrete columns, ranging in size from 12"x24" on the upper floors to 20"x30" at the first floor, support the two-way slab system. Typical interior columns are 14"x30". At the second floor, reinforced concrete transfer girders are used to discontinue several columns from above, providing larger open spaces on the ground floor below.

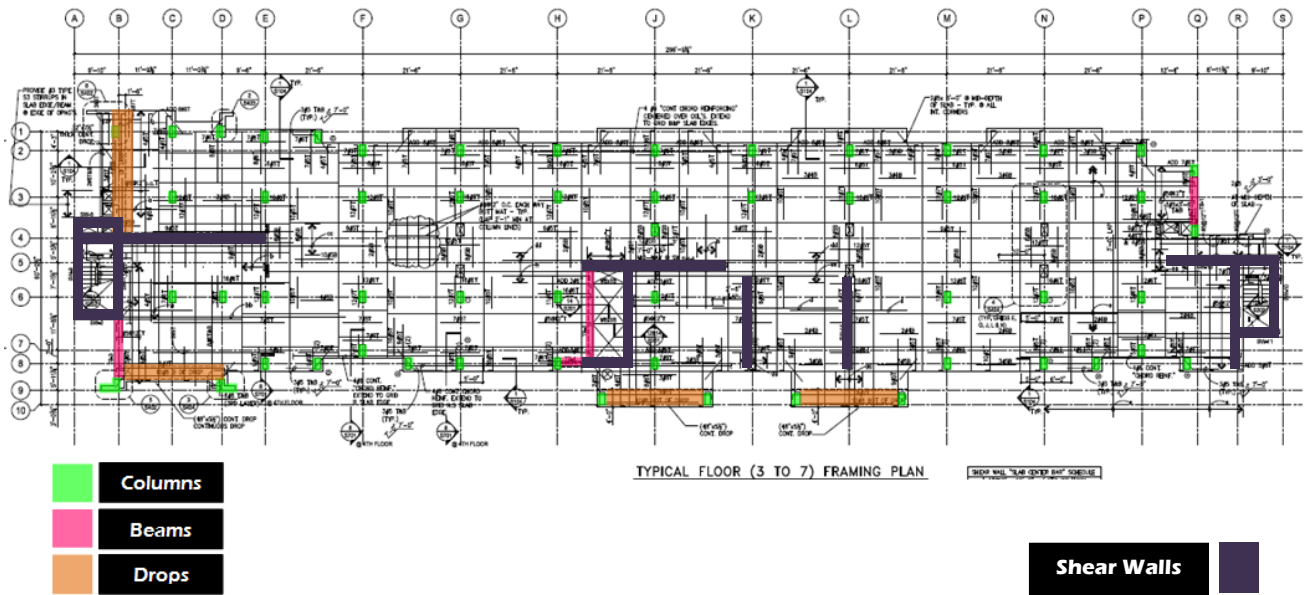

(FIGURE 17) Typical Floor Structural Framing Plan – Original Design

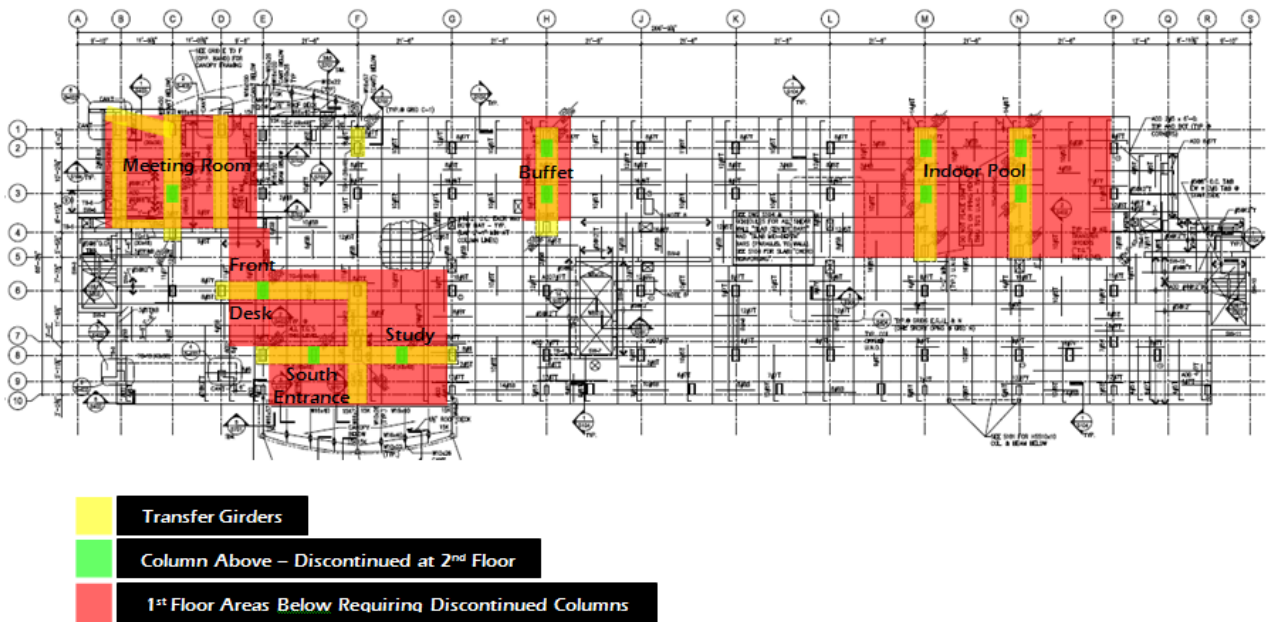

(FIGURE 18) 2<sup>nd</sup> Floor Structural Framing Plan – Original Design

## LATERAL FORCE RESISTING SYSTEMS

Cast-in-place reinforced concrete shear walls are employed to resist lateral forces. There are a total of fourteen shear walls, the majority of which are 1'-0" thick, with a few slightly larger at 1'-2". These shear walls are continuous from the foundation to the top of the building, and behave as fixed cantilevers. Lateral loads are transmitted to the shear walls through the floor diaphragms. Several shear walls located at the west stair tower contain three stories of HSS steel tubing to support an expanse of curtain wall (shown in blue in the elevations below). These frames are rigidly connected to the surrounding concrete shear walls; however, they provide little lateral force resistance as compared with the shear walls. See the figures below for an outline of a typical floor showing shear wall locations and separate figures follow illustrating shear wall elevations.

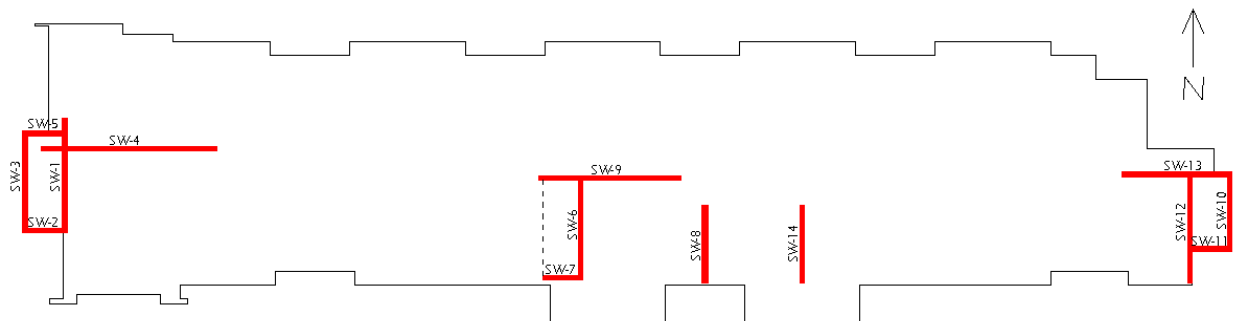

(FIGURE 19) Typical Floor Diaphragm & Shear Wall Layout

North-South Shear Walls

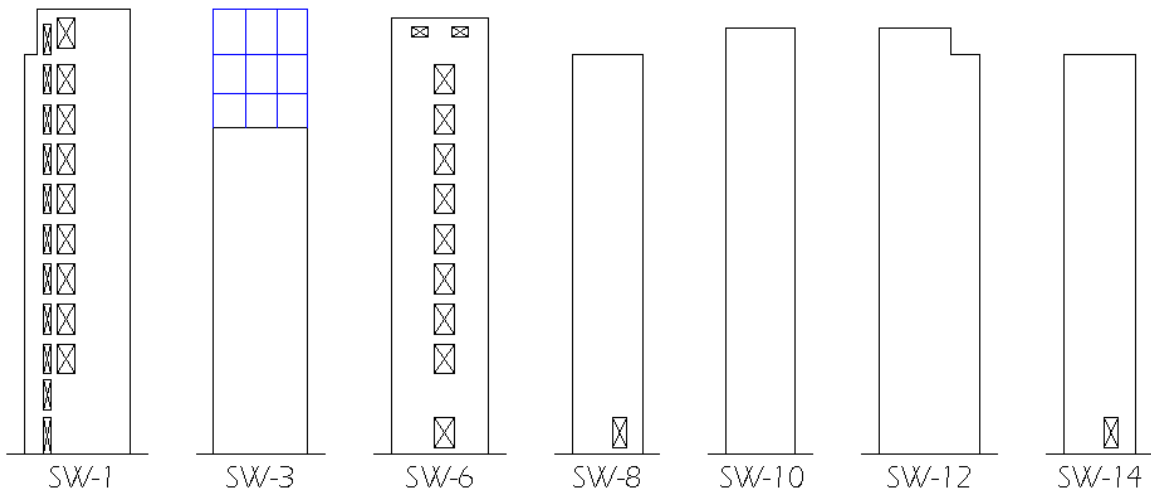

(FIGURE 20) Concrete Shear Wall Elevations – N-S Direction

East-West Shear Walls

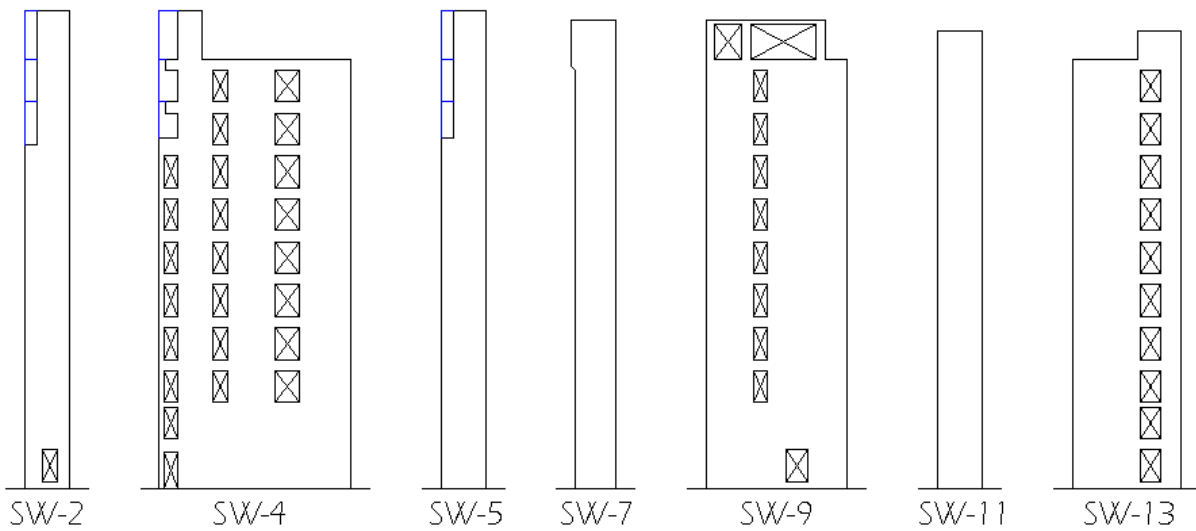

(FIGURE 21) Concrete Shear Wall Elevations – E-W Direction



## **PROBLEM STATEMENT**

Marriott Corporation is one of the leading lodging companies, operating and franchising over 3,000 lodging properties in the United States as well as 67 other countries and territories. The Residence Inn is just one of Marriott's fifteen brands of lodging facilities. Marriott has a variety of types of accommodations, including traditional hotels, the luxurious Ritz-Carlton® and JW Marriott® hotels, and a number of extended-stay business traveler options, including TownePlace Suites® and Marriott Executive Apartments®. While some of these accommodations that are exclusively designed for the extended-stay business traveler have in-room desks and workspace, none of these provides a separate residence and office space in the same building. Frequently, companies who relocate business professionals temporarily also acquire temporary office space. It can be difficult to find space that can be leased for short-term use. It is also very costly to set up these spaces, in terms of furnishing and getting technicians to set up phone and internet access. It is important to keep business professionals content while on the road, and it becomes necessary to invest in professional spaces in which they can meet with clients and be productive. Relative location between residence and office space is also important. Both time and money is saved when the professional does not have to travel significant distances to and from work.

Assuming Marriott pursued this new signature concept of residence and office space in the same building, renting rooms for each on a day-to-day basis, the building would need to increase in size to maintain the desired residence space, while adding office space. Due to the nature of the confined site, the only way to do this is to expand vertically. The marketing department forecasts that the demand for office space is approximately 25 percent of the residence space within the building.

Marriott Corporation is also currently active in the pursuit of "going green," and has proven so in a number of ways, including replacing the 24 million plastic key cards that it purchases annually in the U.S. with those made of 50 percent recycled material. This move alone will save 66 tons of plastic from entering landfills. Other ways include using purchasing pillows filled with a material made from recycled PET bottles, coreless toilet paper, and recycled paper products. Marriott's dedication to the planet can be reinforced by going one step further and incorporating green roof space on its hotels. Green roof spaces provide occupants with a natural place to get some fresh air and take in the magnificent views from

soaring heights. Residents will feel more at home with a space that is almost like their own backyard.

Since Marriott's network of lodging is so expansive and constantly growing, it would be beneficial to have a prototypical structure that could be used in a number of different locations throughout the United States. This would reduce the amount of re-engineering of similar buildings required. The current location of the Residence Inn by Marriott is downtown Norfolk, Virginia, where seismic activity is relatively low. In order to develop a prototype for the structural systems for more locations across the United States, the structure would need to be designed for additional seismic loads. Increased mapped spectral response acceleration parameters of 50% and 15% of gravity for the short and long period accelerations respectively and a more severe Seismic Design Category D shall be used as criteria for the design to ensure that the structure is capable of being located in the most locations. Wind pressures are already relatively high in this region, but it would be worthwhile to consider additional wind loading as well, although seismic loads may prove to be controlling with the proposed changes.

#### SUMMARY OF GOALS:

- Create a new signature brand for Marriott specifically designed to accommodate the needs of the business traveler, adding an office-suite dimension to hotel-style living.
  - Design two additional floors for office suites above existing hotel.
  - Create green roof spaces.
  - Create signature lighting scheme for shared conference rooms.
  - Re-design of gravity load resisting elements to carry additional floors.
- Develop a prototype structural system that is capable of resisting more severe lateral loading conditions based on geographic location in the United States.
  - Develop load criteria & verify geographic range of applicability.
  - Re-design lateral load resisting system for more severe loads.
  - Analyze practicality of over-design for less critical geographic regions.

# ARCHITECTURAL BREADTH

## APPLICABLE CODES

- IBC 2006
- Virginia Uniform Statewide Building Code – 2003 Edition

To address the needs for vertical expansion and green space, a new concept has been developed that merges hotel and temporary office space. The new *Executive* Residence Inn features two additional floors and two separate green roof spaces (See Figures 22 & 23 below). As can be seen in the elevations, the punched window façade has been extended through the ninth floor and the new office suite floors are distinguished using the curtain wall façade. Essentially, the façade and overall look remains just as alluring as the original design, only now the building is soaring to new heights. Each of the additional floors has a floor-to-floor height of 12'-0", slightly higher and more open-feeling than that of the guest room floors where a floor-to-floor height of 9'-4" was used for a more intimate feel. The new 11 story building now has an additional 24 feet, for a total height of 132 feet, including the parapet. This design meets the local zoning restriction for the original site in Norfolk, which mandates a maximum of 11 stories/160 feet. The upper 10<sup>th</sup> and 11<sup>th</sup> floors are set back on the South side, creating green roof space directly accessible from the 10<sup>th</sup> floor and an overlooking deck from the 11<sup>th</sup> floor.



(FIGURE 22) Proposed *Executive* Residence Inn – Rendered Elevations



(FIGURE 23) Proposed *Executive* Residence Inn – Rendered Exterior Perspective

All existing vertical transportation route locations are intended to simply be extended upward to accommodate the additional floors. This solution was necessary to satisfy code requirements for egress. For a complete code analysis, see Appendix A. The location of the new floors was chosen specifically such that office spaces take advantage of the surrounding magnificent views that can be enjoyed most during the waking hours of the day. The original design of the architectural atmosphere for the first floor lobbies and vertical transportation are such that they can serve a dual purpose by providing a professional, yet homey feel. The location of the office suites was an important design consideration to ensure that clients would not feel out of place in route to the office suite floors.

It was also important to consider the implications of the setbacks at the upper levels on the existing mechanical systems. In order to avoid relocation of rooftop mechanical equipment, the footprint of the proposed addition was designed to maintain all vertical shaft opening locations as originally designed. As can be seen in the new Roof Plan shown in Figure 24 below, very few adjustments are necessary and will not affect the operation or air flow of the equipment.

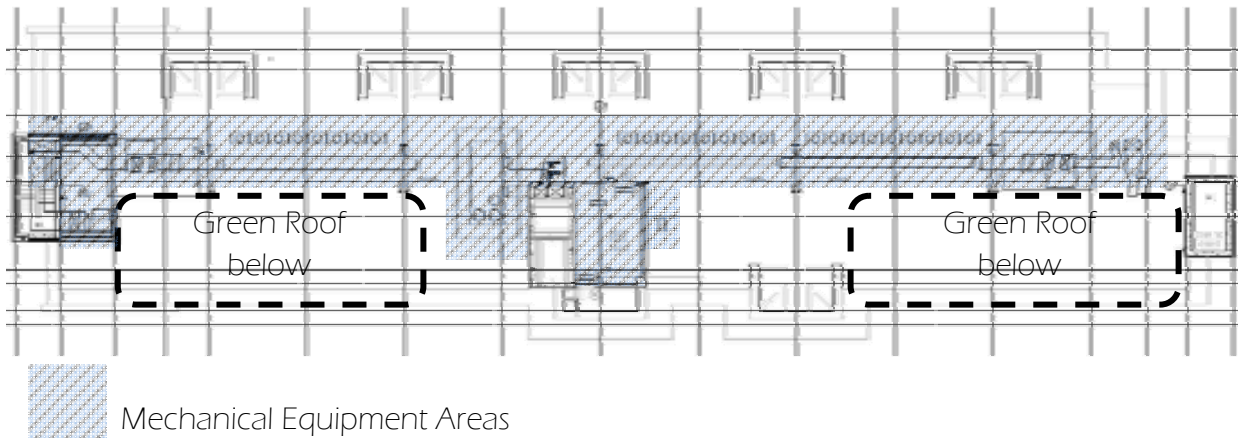

(FIGURE 24) Proposed *Executive* Residence Inn – Roof Plan / Mech. System Locations

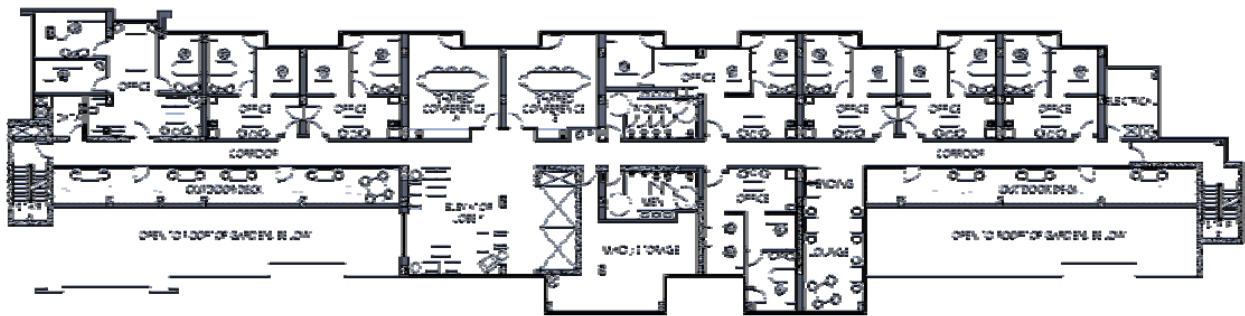

(FIGURE 25) Proposed *Executive* Residence Inn – 11<sup>th</sup> Floor Plan

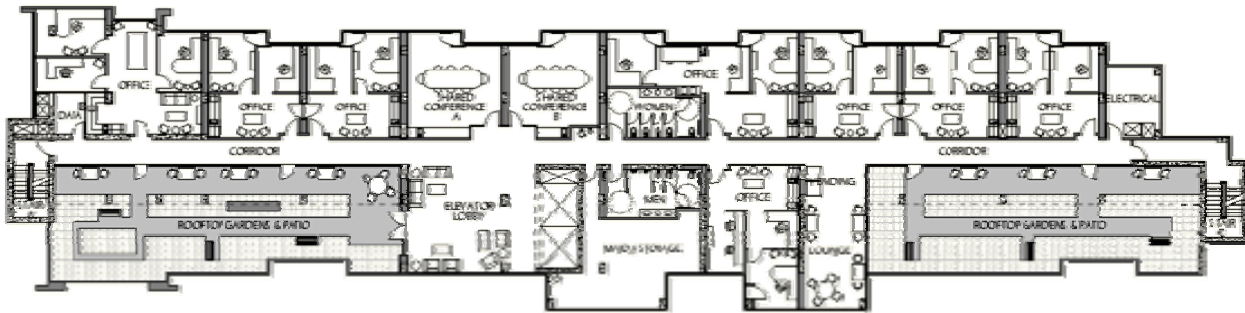

(FIGURE 26) Proposed *Executive* Residence Inn – 10<sup>th</sup> Floor Plan

The new design has carefully considered the needs of the business traveler and his/her clients and/or colleagues. Refer to Figures 25 & 26 for floor plans. Upon arrival on the office suite floor by way of the central elevator, a spacious and open elevator lobby awaits, drawing attention toward an expanse of glass that looks out onto a park-like green roof space. Directly adjacent and conveniently found by arriving clients are two shared conference rooms, each with ample counter space, a sink, and coffee maker for serving refreshments. Tucked behind the central elevator core are the necessary restrooms and drinking fountains. A few steps further, past a couple of office suites, is a private lounge area for professionals to enjoy their lunch while soaking up the view of the East green roof space. The hallway stretches between stair towers at either end and is flanked by office suites to the North. Along the South side of the hall, a floor-to-ceiling curtain wall is used not only to bring in lots of natural light, but also to enjoy the views of the green roofs while pacing the corridor. Eleventh floor occupants can also enjoy the views of the green roof from an outdoor deck space spanning along the corridor. The overhanging slabs of the 11<sup>th</sup> Floor and Roof, necessary to maintain existing column lines, ensure that too much direct heat gain is avoided, while also providing a shady retreat for those who wish to enjoy their lunch outside.

The goal for the office spaces was to create a place that professionals are able to “plug into,” so to speak. Individual offices were designed to accommodate various types of professionals and are equipped with all the necessary furnishings, printers, fax machines, telephones, basic office supplies, and even a small kitchenette for preparing lunch and brewing coffee. There are a variety of sizes and styles of office suites featured on a single floor to satisfy the most discriminating of tastes and needs. Even still, many of the typical office suites have the flexibility of opening up to an adjacent suite for larger groups of colleagues working together. The concept is based on the idea that the business traveler can come into town, get a good night’s rest in his/her hotel room, travel a short distance down the hall and up the elevator to work, plug his/her laptop into the internet connection, and “voilà!” he/she is ready to begin a productive day. Not only that, but he/she has a professional environment in which to meet with clients and, depending on the length of stay, can leave office work set up for the next day in a secure environment. In the fast-paced business world today, it is important for many to separate their work life from personal life, and this is a logical way to do so. The design eases the burden of being away from home by creating some normalcy in routine and work atmosphere for the traveling professional.

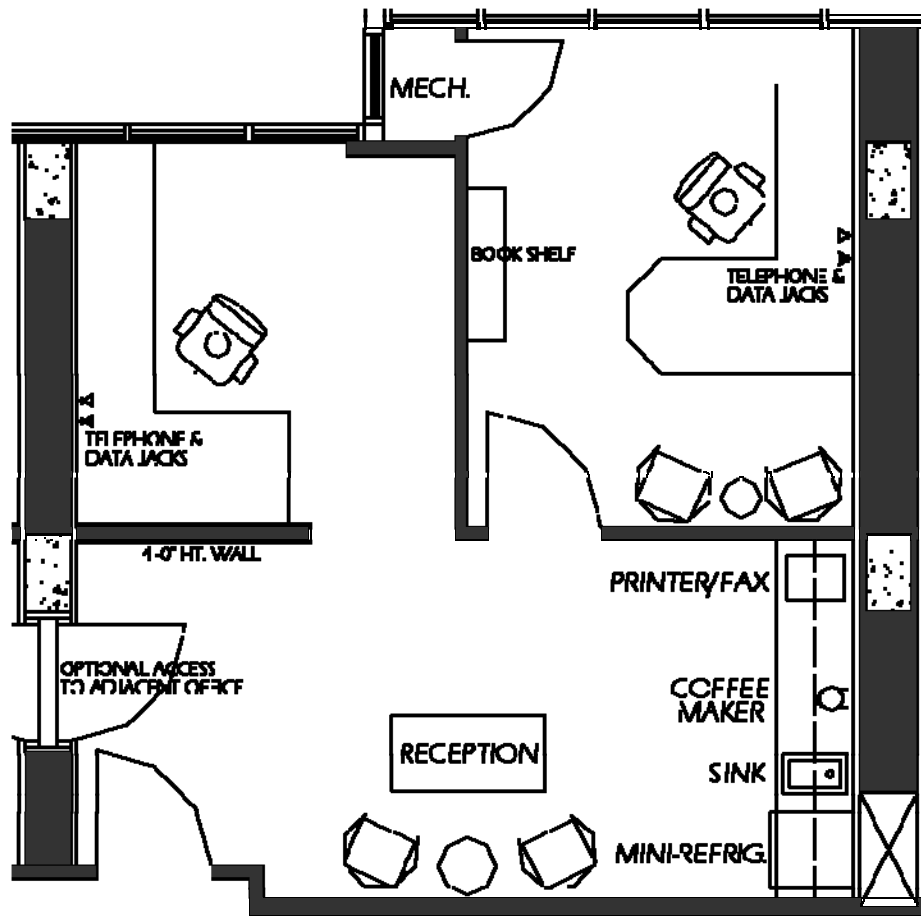

(FIGURE 27) Proposed *Executive* Residence Inn - Design Solution for Individual Office Space

The green roofs were a significant aspect of the architectural design. The vision for these was to re-connect the traveling business professional to more of the comforts of home by fusing the invisible boundary between the confines of the business world and nature. The design creates a park-like setting that fosters relaxation and is a quiet place for reflection while absorbing the vista that surrounds. Practically speaking, it was necessary to choose a modular green roof system which is easy to install, low maintenance, and can be easily customized for sake of the prototype design. The GreenGrid® system comes in modules 2 feet by 4 feet wide, is lightweight, and features drought-resistant plants. It is installed over the regular built-up roof below; and therefore, does not require tedious detailing to prevent leaks in the finished spaces below. A bonus attribute is its insulating properties that will positively reduce heat gains/losses. With the use of GreenGrid® recycled rubber pavers that serve as

walkways, Marriott's dedication to the environment is even further supported. See Appendix A for a summary specification of the GreenGrid® system.



(FIGURE 28) GreenGrid® Modular Green Roof System



## LIGHTING BREADTH

Since an important aspect of the re-design is separation of work and personal spaces, the new office suite floors' shared conference rooms were designed to exhibit lighting characteristics that are both efficient and foster productivity with invigorating style. An energy-saving 1'x4' Avante® Surface-Mounted Linear Fluorescent with (1) T5, High Output lamp was chosen for its contemporary look and suitability for conference room spaces (Figure 29). Cooler tones of the high output fluorescent give the sense of office space as opposed to the warmer hues used to illuminate residential spaces. The fixture's semi-direct light distribution is ideal for avoiding harsh shadows while providing efficiency. In order to avoid damage in high seismic regions, it was decided that a surface-mounted luminaire would be better as opposed to the suspended version. See Appendix B for luminaire specification and photometric report. Recessed lighting would not have been feasible due to the nature of the finished ceiling, which is simply the painted underside of the concrete floor slab above.

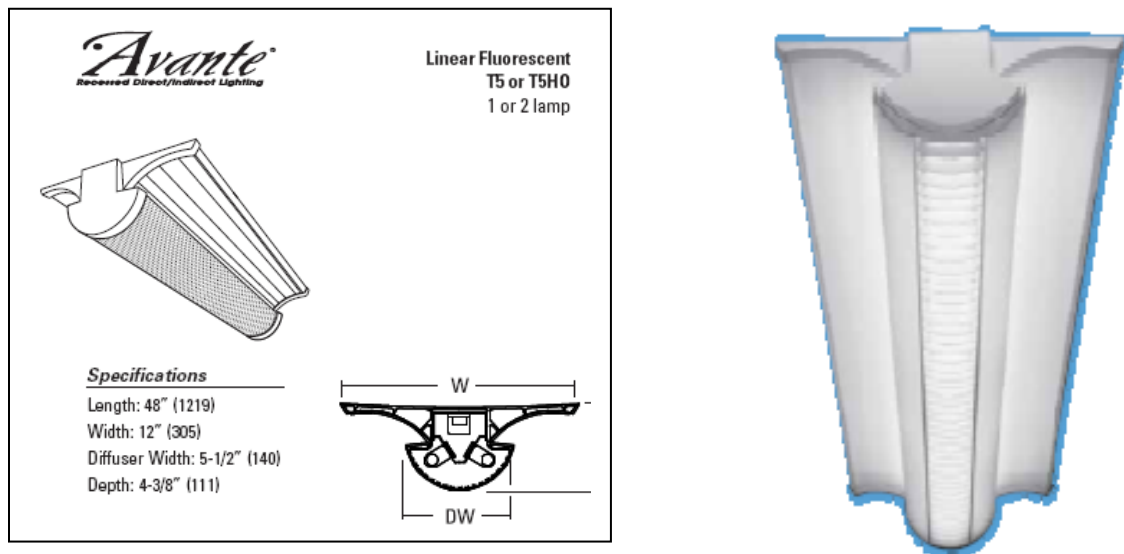

(FIGURE 29) Luminaire Selection – Shared Conference Room

The conference room space was designed using the Lumen Method to determine the number of luminaires required. The target illuminance for the space was 30 footcandles, as required by the IESNA Handbook. For detailed calculations using this method, including other assumptions and factors used to determine the light loss factor, see Appendix B. An electronic program start ballast manufactured by Osram Sylvania was selected and the ballast factor based on the published information for this device was 1.0. See Appendix B for more information on the ballast selection. Based on the calculation, a total of eight luminaires was required for each conference room, which provides just under 31 footcandles of illuminance. After carefully considering maximum spacing requirements of 11'-5" along and 13'-1" perpendicular to the fixtures, the layout in Figure 30 was achieved. Luminaires are oriented in such a way that does not inhibit projected presentations, which are anticipated to utilize the side walls. By aligning them end-to-end, a clean look is achieved, symbolic of the streamline and productive activities that will ensue in the space. Scallops were avoided by maintaining sufficient distance from the adjacent walls. Besides illuminating the conference table itself, it was important to focus more of the light near the refreshment counter. It was assumed that it would be unnecessary to place luminaires in the corner closest to the windows because this space is not anticipated to be used for tasks other than to create a viewing area of the cityscape that surrounds.

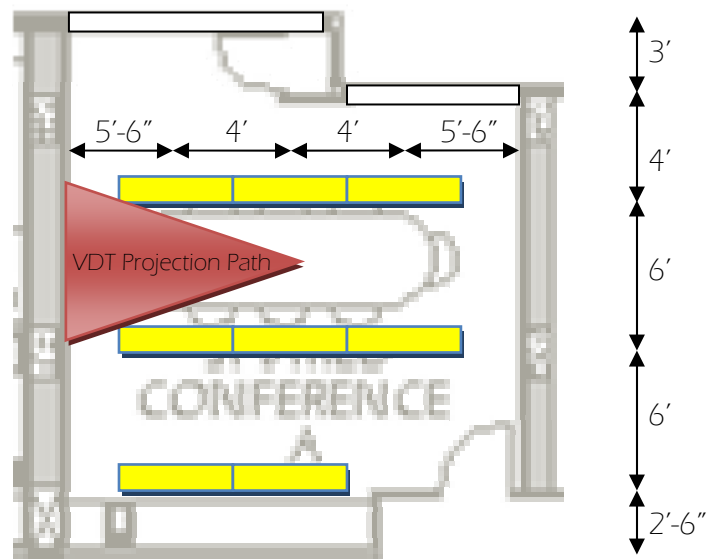

(FIGURE 30) Lighting Design Plan – Shared Conference Room

# STRUCTURAL DEPTHS

## APPLICABLE CODES/REFERENCED STANDARDS

- IBC 2006
- ASCE 7-05
- ACI 318-08

Building Drift Limitations:

- $H/400$  (Accepted value for service loads (D+L+W); Structural Engineering Handbook, 1968)
- $0.020h_{sx}$  Story Drift – Seismic (for a typical story  $\Delta_{s,max} = 2.28"$  (9'-6" story height))

## LOAD COMBINATIONS

The following factored load combinations, prescribed by ASCE 7-05, Chapter 2, are applicable to this lateral load analysis:

(Note:  $D_i$ ,  $F$ ,  $F_a$ ,  $H$ ,  $R$ ,  $T$ , &  $W_i$  are assumed to be zero)

1.  $1.4D$
2.  $1.2D + 1.6L + 0.5(L_r \text{ or } S)$
3.  $1.2D + 1.6(L_r \text{ or } S) + (L \text{ or } 0.8W)$
4.  $1.2D + 1.6W + L + 0.5(L_r \text{ or } S)$
5.  $(1.2 + 0.2S_{DS})D + PE + L + 0.2S$
6.  $0.9D + 1.6W$
7.  $(0.9 - 0.2S_{DS})D + PE$

## GRAVITY SYSTEMS

### REVISED GRAVITY LOADS

The basic layout of structural elements, such as column and core area locations that provide the necessary vertical transportation, remained as originally designed. With the addition of two floors with a differing occupancy and the introduction of a green roof, both dead and live loads increased significantly on the new upper floors. Since it was determined that the two-way flat plate floor system is one of the most economical choices for this particular building, the same system is utilized. A logical assumption was that the original size of the columns would be a minimum starting point for the more critical loads. Therefore, assuming that 14"x30" columns are used on the upper floors, the two-way slab was checked for these additional loads, resulting in the need for a 10 inch slab, slightly thicker than the 8 inch slab utilized on the typical hotel floors. For detailed slab check calculations, see Appendix C. The dead weight of the thicker slab has been incorporated into the dead loads represented in Figure 31 below. Where the GreenGrid® system occupies the 10<sup>th</sup> Floor, the slab saw an additional 45 psf. Live loads increased, with the maximum being the outdoor rooftop area, which requires 100 psf by code. The variation in live loads on the 10<sup>th</sup> Floor is illustrated by Figure 32 below. The worst case loading (195 psf DL + 100 psf LL), along with the appropriate critical load combinations was used in the re-design of the two-way slab on these floors. See the figure below for a comparison summary.

Revised Gravity Loads (psf)				
Location	Dead (Incl. Self-Wt. of Slab)		Live	
	Original	New	Original	New
Roof	135	135	30	30
11th	-	150	-	50/80/100
10th	-	195	-	50/80/100
Typical Floors 2nd-9th	125	125	40	40

(FIGURE 31) Proposed *Executive* Residence Inn - Revised Gravity Load Summary



(FIGURE 32) Proposed *Executive* Residence Inn – Office Suite / Green Roof Live Loads

## COLUMN RE-DESIGN

The addition of two stories inevitably made it necessary to assess the existing column design, especially on the lower floors, where accumulating loads is critical. In addition to the gravity loads based on tributary area, the columns experience significant unbalanced moment due to the two-way flat plate slab framing into them. Edge columns are most critical for this condition due to the significant unbalanced moment that is induced. Additional moment is introduced with the drift of the building. This condition was accounted for by assuming a worst case scenario, which would be an eccentricity of the axial load a distance equal to the maximum allowable story drift (See Figure 33 below). Slenderness of the columns was considered using the unbraced lengths of the columns, which range from 9'-4" on a typical hotel floor to 19 feet at the first floor. Weak axis and strong axis column orientations were intended to remain as originally designed. For practical design purposes, four columns (highlighted in gray in Figure 34 below) were carefully chosen to calculate design loads, which represent the most critical cases. Largest tributary area, most number of stories rising above, and edge columns with the most severe dead and live loads were all factors in the decision of which columns to assess. The maximum tributary area occurs at column lines G6 and N6, shown below.

Allowable Story Drift (X-Direction)	
Floor	$\Delta_{sx, allow}$ (in)
	Roof
11th	2.88
10th	2.24
9th	2.24
8th	2.24
7th	2.24
6th	2.24
5th	2.24
4th	2.24
3rd	2.24
2nd	4.56

Allowable Story Drift (Y-Direction)	
Floor	$\Delta_{sy, allow}$ (in)
	Roof
11th	2.88
10th	2.24
9th	2.24
8th	2.24
7th	2.24
6th	2.24
5th	2.24
4th	2.24
3rd	2.24
2nd	4.56

(FIGURE 33) Allowable Story Drifts – Worst Case Scenario for Columns

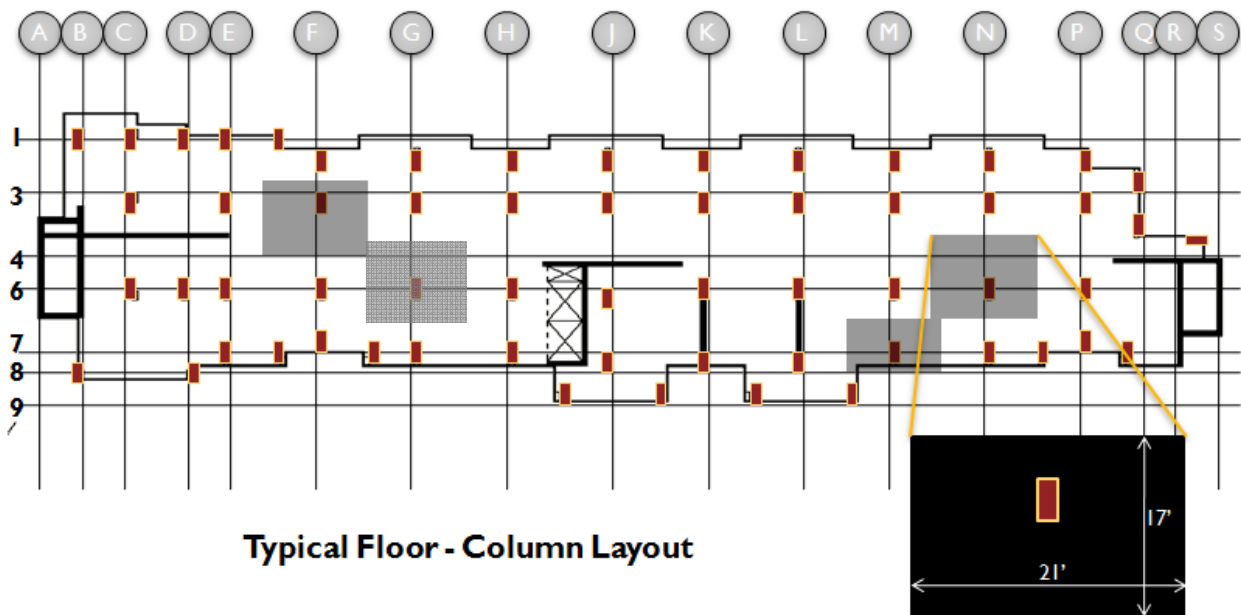

(FIGURE 34) Critical Column Locations

A summary of the axial loads and moments on the selected critical columns is shown in Figures 35-38 below. PCA Column was used to assess column sizes for the interaction between the unbalanced moments and gravity loads. Highlighted values (Column N-6) were plotted, analyzing strong and weak axes separately, including the effects of slenderness. The resulting critical column proves that tributary area alone cannot be depended on to assess which column would be most critical. The tributary area decreases for Column N-6 at the 11<sup>th</sup>

Floor and Roof levels; however the resulting unbalanced moment is significant enough to make it the critical case, especially in the weak axis direction. For complete calculations of unbalanced moments and PCA Column output verifying the design, see Appendix C.

Column F-3										
Level	Height (FT)	Trib. Area (SF)	Dead Load (PSF)	$L_o$ (PSF)	LL Reduction Factor	Axial [1.2D + 1.6L] (k)	Max Story Drift (in)	Story Drift Moment	Factored Total Moment (FT-K) (STRONG Axis)	Factored Total Moment (FT-K) (WEAK Axis)
Roof	0	344	125	30	0.654	0	2.88	0.00	0.0	0.0
11th	12	344	150	65	0.536	62	2.88	14.98	37.9	18.7
10th	12	344	150	65	0.500	148	2.24	27.60	57.0	33.6
9th	9.33	344	125	40	0.500	232	2.24	43.32	72.7	49.3
8th	9.33	344	125	40	0.500	300	2.24	55.92	78.8	59.6
7th	9.33	344	125	40	0.500	367	2.24	68.52	91.4	72.2
6th	9.33	344	125	40	0.500	435	2.24	81.12	104.0	84.8
5th	9.33	344	125	40	0.500	502	2.24	93.72	116.6	97.4
4th	9.33	344	125	40	0.500	570	2.24	106.33	129.2	110.0
3rd	9.33	344	125	40	0.500	637	2.24	118.93	141.8	122.6
2nd	9.33	344	125	40	0.500	705	2.24	131.53	154.4	135.2
1st	19	344	125	40	0.500	772	4.56	293.41	316.3	297.1

(FIGURE 35) Critical Loads – Column F-3

Column G-6										
Level	Height (FT)	Trib. Area (SF)	Dead Load (PSF)	$L_o$ (PSF)	LL Reduction Factor	Axial [1.2D + 1.6L] (k)	Max Story Drift (in)	Story Drift Moment	Factored Total Moment (FT-K) (STRONG Axis)	Factored Total Moment (FT-K) (WEAK Axis)
Roof	0	235	125	30	0.739	0	2.88	0.00	0.0	0.0
11th	12	235	150	100	0.596	44	2.88	10.46	52.8	59.1
10th	12	393	195	100	0.505	113	2.24	21.09	105.3	118.2
9th	9.33	393	125	40	0.500	239	2.24	44.54	70.9	55.8
8th	9.33	393	125	40	0.500	314	2.24	58.69	72.9	63.2
7th	9.33	393	125	40	0.500	391	2.24	72.96	87.2	77.5
6th	9.33	393	125	40	0.500	467	2.24	87.22	101.4	91.7
5th	9.33	393	125	40	0.500	544	2.24	101.49	115.7	106.0
4th	9.33	393	125	40	0.500	620	2.24	115.75	130.0	120.3
3rd	9.33	393	125	40	0.500	697	2.24	130.02	144.2	134.5
2nd	9.33	393	125	40	0.500	773	2.24	144.29	158.5	148.8
1st	19	393	125	40	0.500	849	4.56	322.77	337.0	327.3

(FIGURE 36) Critical Loads – Column G-6

Column N-6										
Level	Height (FT)	Trib. Area (SF)	Dead Load (PSF)	$L_o$ (PSF)	LL Reduction Factor	Axial [1.2D + 1.6L] (k)	Max Story Drift (in)	Story Drift Moment	Factored Total Moment (FT-K) (STRONG Axis)	Factored Total Moment (FT-K) (WEAK Axis)
Roof	0	237	125	30	0.737	0	2.88	0.00	0.0	0.0
11th	12	237	150	100	0.594	44	2.88	10.54	128.5	116.5
10th	12	395	195	100	0.504	114	2.24	21.25	150.2	137.2
9th	9.33	395	125	40	0.500	240	2.24	44.80	77.0	55.4
8th	9.33	395	125	40	0.500	316	2.24	59.04	76.9	63.2
7th	9.33	395	125	40	0.500	393	2.24	73.37	91.3	77.6
6th	9.33	395	125	40	0.500	470	2.24	87.71	105.6	91.9
5th	9.33	395	125	40	0.500	547	2.24	102.04	119.9	106.2
4th	9.33	395	125	40	0.500	623	2.24	116.37	134.3	120.6
3rd	9.33	395	125	40	0.500	700	2.24	130.71	148.6	134.9
2nd	9.33	395	125	40	0.500	777	2.24	145.04	162.9	149.2
1st	19	395	125	40	0.500	854	4.56	324.44	342.3	328.6

(FIGURE 37) Critical Loads – Column N-6

Column M-8										
Level	Height (FT)	Trib. Area (SF)	Dead Load (PSF)	$L_o$ (PSF)	LL Reduction Factor	Axial [1.2D + 1.6L] (k)	Max Story Drift (in)	Story Drift Moment	Factored Total Moment (FT-K) (STRONG Axis)	Factored Total Moment (FT-K) (WEAK Axis)
Roof	0	0	125	30	1.000	0	2.88	0.00	0.0	0.0
11th	0	0	150	100	1.000	0	2.88	0.00	0.0	0.0
10th	0	156	195	100	0.850	0	2.24	0.00	0.0	0.0
9th	9.33	156	125	40	0.675	58	2.24	10.78	61.6	109.3
8th	9.33	156	125	40	0.597	88	2.24	16.50	44.1	70.0
7th	9.33	156	125	40	0.550	120	2.24	22.38	50.0	75.9
6th	9.33	156	125	40	0.519	152	2.24	28.30	55.9	81.8
5th	9.33	156	125	40	0.500	183	2.24	34.23	61.8	87.7
4th	9.33	156	125	40	0.500	215	2.24	40.21	67.8	93.7
3rd	9.33	156	125	40	0.500	249	2.24	46.43	74.0	99.9
2nd	9.33	156	125	40	0.500	282	2.24	52.64	80.2	106.1
1st	19	156	125	40	0.500	315	4.56	119.82	147.4	173.3

(FIGURE 38) Critical Loads – Column M-8



Critical loads were assessed on multiple floors in order to check if column sizes could be decreased on the upper floors. However, it was found that, due to the larger unbraced lengths of said columns, this was not feasible. The design does not seek to economize every single column, but rather generate the most critical case and specify that for the entire floor. This would typically be done in the design field so as to make the structure easily interpreted for design and construction. The results of the design are summarized in Figure 39 below, along with a comparison to the column design for the original 9 story building.

Critical Column Design										
		9 Stories			Re-Design - 11 Stories			% Increase w/ 2 Additional Stories		
Level	Height (FT)	Column Size (in x in)	Reinf.	$f_c$ (ksi)	Column Size (in x in)	Reinf.	$f_c$ (ksi)	Volume of Concrete	Reinf.	Concrete Strength
11th	12	-	-	-	14 x 24	(8) #8	5	100	100	N/A
10th	12	-	-	-	14 x 24	(8) #8	5	100	100	N/A
9th	9.33	12 x 20	(6) #8	5	14 x 24	(6) #8	5	40	0	0
8th	9.33	12 x 20	(6) #8	5	14 x 24	(6) #8	5	40	0	0
7th	9.33	12 x 20	(6) #8	5	14 x 24	(6) #8	5	40	0	0
6th	9.33	12 x 20	(6) #8	5	14 x 24	(6) #8	5	40	0	0
5th	9.33	12 x 20	(6) #8	5	14 x 24	(6) #8	5	40	0	0
4th	9.33	12 x 30	(6) #8	5	14 x 30	(6) #8	5	17	0	0
3rd	9.33	12 x 30	(6) #8	5	14 x 30	(6) #8	5	17	0	0
2nd	9.33	12 x 30	(6) #8	5	14 x 30	(6) #8	5	17	0	0
1st	19	18 x 30	(8) #8	5	20 x 30	(8) #8	5	11	0	0

(FIGURE 39) Gravity Column Re-Design Summary

Initially, the results were surprising, considering a reduced size was found to be adequate even after the addition of two floors, as compared with the original design. However, there are explanations for this. After careful review of the original design, it appears that the designer may not have taken advantage of live load reductions, which can reduce axial loads up to 50% on the lower floors. This would result in significantly larger axial loads, especially as they accumulate at the lower floors, and the subsequent moment induced due to story drift would then also be exaggerated. The original design, using 5 ksi and 4 ksi

concrete for the first four floors and upper floors respectively, was changed to a consistent use of 5 ksi concrete in the re-design in order to avoid an increased column size and critical punching shear situation for the 10<sup>th</sup> and 11<sup>th</sup> Floors, which have a significantly higher unbraced length and gravity loads. So, whereas the original design steps down the concrete strength after the fourth floor, the re-design instead features a reduced column section for economy. Because choice of economy in design was not the only factor that explains the differences, it was necessary for comparison to use the calculated design loads, removing the added two floors. In this way, a direct comparison between the results can be made and the design influence of these floors is realized. See Figure 39 above for a summary of these results.

Observing the percentage increases in volumes of concrete required to carry the additional loads reveals an average of a 30% increase in concrete for the columns of the existing structure, which correlates with a 22% increase in building size. The increase in materials does not include the structure that rises above, but rather what would be necessary to strengthen the structure below. Therefore, adding to the building vertically does not correspond to a proportional relationship in terms of the structure below. However, it could be argued that the additional load created by the introduction of green roof space is skewing the comparison slightly. This clearly illustrates the law of diminishing returns. In addition, foundations would need to be analyzed and likely strengthened to account for the additional loads; however, due to the prototypical nature of this thesis, which seeks a preliminary design independent of a particular site, it is beyond the scope of this work.

## GRAVITY SYSTEMS CONCLUSIONS

With the introduction of just two additional floors projecting vertically from the originally designed structure, corresponding to a 22% increase in overall building size, lower level column sizes were found to increase on average by 30%. This result indicates a diminishing return on gravity structural systems. Perhaps a more economical solution would have been to expand the footprint of the building to accommodate the additional program requirements; however, for this particular site in Norfolk, VA, this would not have been a feasible alternative. Almost all column designs were governed by slenderness, or a tendency

for the columns to buckle due to unbraced lengths between stories. Small increases in unbraced lengths with similar axial loads have a tremendous impact on the strength of the column to resist buckling. Moments induced in the columns due to drift were found to be most significant at the lower stories, due to the increased affect with larger axial loads found there. In general, the results were as expected: increased column sizes to resist larger gravity loads.

## LATERAL SYSTEMS

In order to develop a prototype structure that has the flexibility of a majority of geographic locations within the continental United States, it was necessary to define a number of assumptions and criteria for lateral wind and seismic loads, which are largely governed by location. The author realizes that variations exist for snow loading as well; however, it is assumed that the slab re-design, which already accounts for a significantly increased live load of 100 psf would most likely allow the structure to be sufficient for those geographic regions with more severe snow loads than that of Norfolk, VA (ground snow load = 10 psf).

## WIND LOADING CRITERIA

The increased height of the building, with the addition of two stories, required re-calculation of previously determined wind loads. However, in order to accommodate a larger geographic region of possibilities for the prototype, the basic wind speed was also increased from 110 mph (Norfolk, VA) to 120 mph, which will allow the prototype to be applicable to more of the coastal areas of the US. Figure 40 below illustrates the geographic feasibility of the proposed wind loading criteria.

Basic Wind Speed  
(3-second gust)

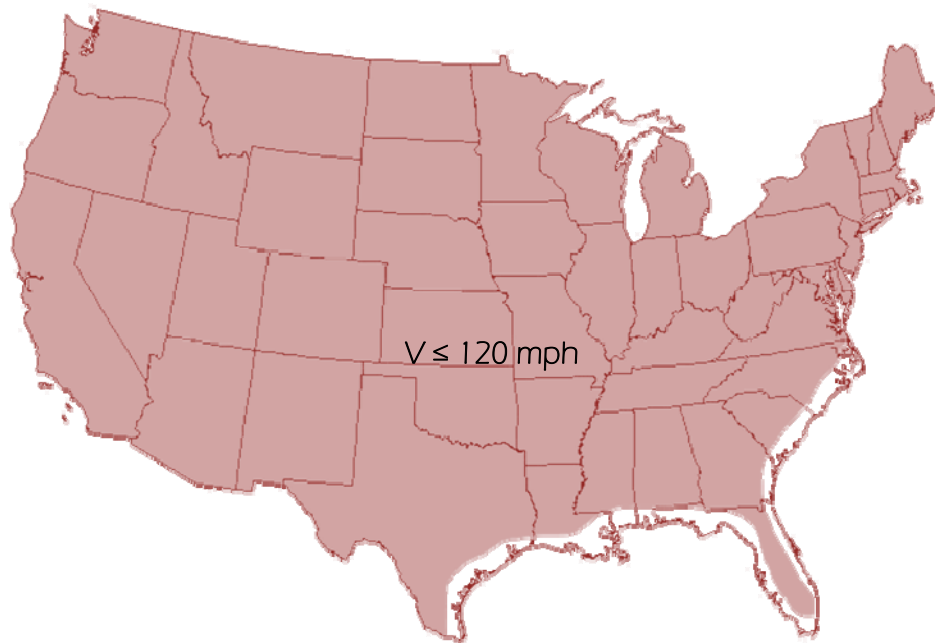

(FIGURE 40) Wind Loading Criteria

Other assumptions were necessary in order to calculate actual wind loads on the building. The prototype assumes Exposure Category B because it is unlikely that a building of this size and function would be located anywhere other than an urban or suburban area with closely spaced obstructions larger than single family dwellings with 2,700 feet. Topography assumes that the prototype is not located on a hill, again a reasonable assumption for this type of building, and therefore, the topographic factor,  $k_{zt} = 1.0$ . In the unlikely event that these assumptions are not met, adjustments would need to be made to account for a more critical case. Initially, it was also necessary to assume a rigid structure, which was later verified as true during the seismic load analysis. A summary of the revised wind load calculations, based on the Analytical Procedure prescribed by Chapter 6 of ASCE 7-05, is shown in Figures 41 & 42 below. More detailed spreadsheets for these calculations are available upon request. Note that the for sake of the prototype, of which its exact location is yet to be determined, the notation of the X and Y directions is introduced and refers to the original location being the E-W and N-S directions respectively.

<b>EAST-WEST (X-DIREC) WIND LOAD</b>							
Floor	Location	Height Above Ground Level	Total Pressure WW+(-LW)	Story Force	Factored Story Force	Story Shear	Overturning Moment
		h (ft)	$p_t$ (psf)	$F_x$ (k)	$1.6 * F_x$ (k)	$V_x$ (k)	$M_x$ (ft-k)
W Stairwell	Windward	129.67	46.15	6.70	10.72	6.70	868.91
Roof		117.67	45.50	45.25	72.41	51.95	5,324.99
11th		105.67	44.76	34.91	55.86	86.86	3,688.90
10th		93.67	44.08	30.57	48.91	117.43	2,863.38
9th		84.33	43.56	26.44	42.31	143.88	2,230.08
8th		75.00	42.86	26.02	41.63	169.90	1,951.46
7th		65.67	42.06	25.54	40.86	195.43	1,676.98
6th		56.33	41.27	25.05	40.09	220.49	1,411.26
5th		47.00	40.40	24.53	39.25	245.02	1,152.87
4th		37.67	39.36	23.90	38.24	268.91	900.22
3rd		28.33	38.10	23.13	37.01	292.04	655.26
2nd		19.00	36.47	33.59	53.74	325.63	638.17
	Leeward	ALL	Base Shear	325.63	521.01	M =	23,362

(FIGURE 41) East-West (X-Direc) Wind Pressures, Forces, & Overturning Moment Summary

<b>NORTH-SOUTH (Y-DIREC) WIND LOAD</b>							
Floor	Location	Height Above Ground Level	Total Pressure WW+(-LW)	Story Force	Factored Story Force	Story Shear	Overturning Moment
		h (ft)	$p_t$ (psf)	$F_x$ (k)	$1.6 * F_x$ (k)	$V_x$ (k)	$M_x$ (ft-k)
W Stairwell	Windward	129.67	34.38	2.50	3.99	2.50	323.64
Roof		117.67	33.73	137.68	220.29	140.18	16,200.9
11th		105.67	32.98	105.59	168.95	245.77	11,157.8
10th		93.67	32.30	91.95	147.12	337.72	8,613.18
9th		84.33	31.79	79.20	126.72	416.92	6,679.19
8th		75.00	31.09	77.46	123.93	494.38	5,809.34
7th		65.67	30.29	75.48	120.76	569.86	4,956.48
6th		56.33	29.50	73.49	117.59	643.35	4,139.87
5th		47.00	28.63	71.34	114.15	714.69	3,353.05
4th		37.67	27.59	68.75	110.00	783.44	2,589.78
3rd		28.33	26.33	65.60	104.96	849.04	1,858.38
2nd		19.00	24.70	93.35	149.36	942.39	1,773.67
	Leeward	ALL	Base Shear	942.39	1507.82	M =	67,455

(FIGURE 42) North-South (Y-Direc) Wind Pressures, Forces, & Overturning Moment Summary

## SEISMIC LOADING CRITERIA

Seismic loads inevitably increased from the original design due to the additional mass of the two office suite floors. For complete calculations of the seismic weight, see Appendix D. Since Norfolk, VA is a relatively low-seismic activity region, the prototype would have limited geographic feasibility if the parameters were based on that location. Therefore, after carefully studying the mapped spectral response acceleration maps from ASCE 7-05, it was decided that spectral response acceleration values of 50% and 15% for the short and long period accelerations respectively shall be the criteria for design of the prototype. Maps illustrating the chosen criteria are shown in Figure 43 below.

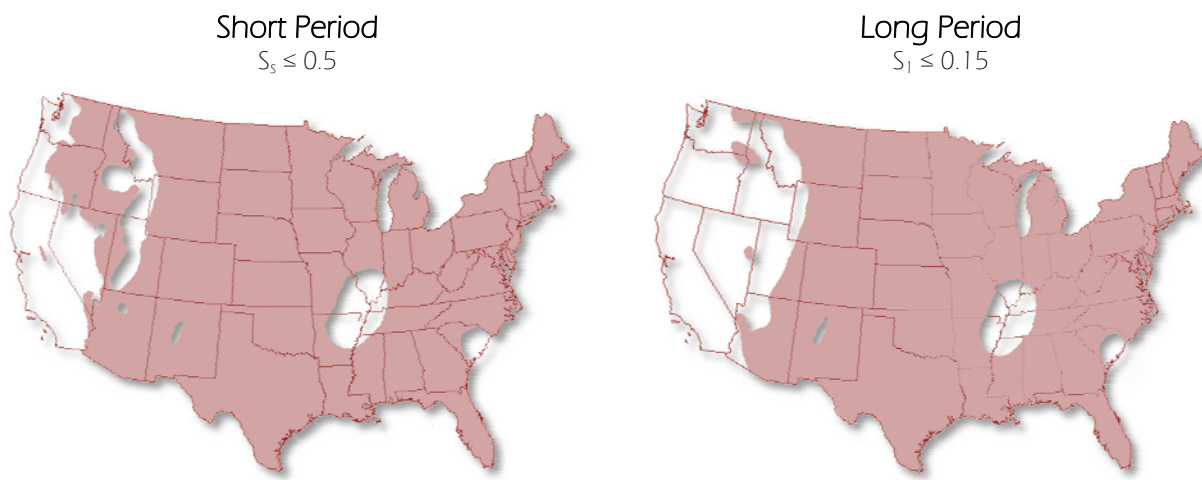

(FIGURE 43) Seismic Loading Criteria

Many other assumptions were also necessary and influenced the resulting seismic loads. Site Class D for stiff soil was chosen since in general this would be assumed if soil conditions were unknown, making it a conservative assumption. Based on the occupancy type, Type II, an importance factor of 1.0 was used. Based on the assumed criteria, the resulting Seismic Design Category was determined to be SDC-D. Therefore, special reinforced concrete shear walls were required by code in lieu of ordinary reinforced concrete shear walls. The system overstrength factor,  $\Omega = 2.5$ , and redundancy factor,  $P = 1.3$ . Per code, this type of structural system is limited to a maximum height of 160 feet, of which this building is well within. Using the provisions of ASCE 7-05, Chapter 11, an approximate building period of  $T_a$

= 0.769 sec. was found. For a complete list of assumptions and seismic coefficient determination, see Appendix D. At this stage, it was necessary to begin creating a computer model of the structure to obtain a more accurate representation of the building's response to dynamic loading (periods) and to determine the fundamental period. The periods determined by ETABS are as follows:

- $T_x = 1.077$  sec.
- $T_y = 1.436$  sec.
- $T_z = 0.857$  sec.

#### ETABS MODEL - OVERVIEW OF ASSUMPTIONS

ETABS was utilized (Figure 44), modeling lateral force resisting elements only, but accounting for the mass of the structure by assigning additional area masses to the diaphragms on each floor. Masses applied included the self weight of the two-way flat-plate slab, all superimposed dead loads (which vary on the upper floors), and column weights, distributed as a uniform load on the diaphragms. All diaphragms were modeled as rigid, and only minor openings were omitted for ease of construction. With a few simplifying assumptions, a fairly representative and accurate model was successfully created. Shear walls were modeled as shell elements, manually meshed at a maximum size of 24"x24", and fixed at their bases, thus behaving as cantilevers. In an effort to represent actual conditions as they relate to stiffness, openings in shear walls were created by deleting areas after meshing. Per the requirements of ASCE 7-05, Chapter 12, cracked sections were considered by reducing the stiffness by 50%. Although not required by code, P-Delta effects were also included since the program takes care of accounting for these effects by simply clicking on a radio button. All lateral loads are applied at the center of mass of each diaphragm. As a more experienced user of the program, it was much easier to spot errors in the output, and therefore, simple spot checks were performed continually to ensure that the modeling assumptions were representative of actual conditions.

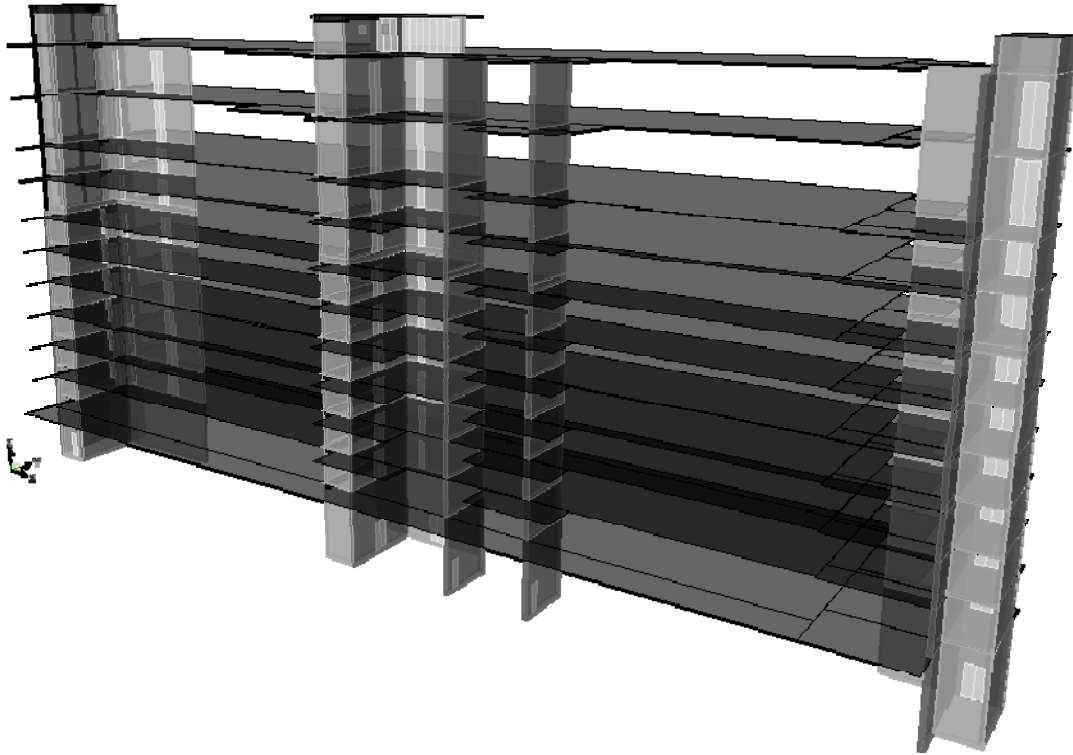

(FIGURE 44) ETABS Model – Lateral Force Resisting Systems

#### MAE ACKNOWLEDGEMENT – COMPUTER MODELING

For a majority of lateral system analysis, the finite element program ETABS was utilized. The use of this program to understand and obtain critical design loads for shear walls shall be used to fulfill the MAE requirement. Additional work in the area of seismic design of concrete structures shall also be used to fulfill this requirement.

#### SEISMIC LOADS - EQUIVALENT LATERAL FORCES

Equivalent lateral forces were determined based on the effective seismic weight (refer to Appendix D) and the seismic response coefficient,  $C_s$ , was determined from the stated assumptions and fundamental periods. Base shears were then calculated and distributed to each floor based on the provisions of the Equivalent Lateral Force Procedure. The resulting story forces and story shears are summarized in Figures 45 & 46 below.



<b>X-DIRECTION (E-W)</b>			<b>SEISMIC LOAD DISTRIBUTION</b>						
			T= 1.077		V <sub>b</sub> = 963				
			k= 1.289						
Floor	Weight	Height	Vertical Distribution Factor	Story Force	Story Shear	Accidental Torsional Moment	COM/COR Eccentricity	Inherent Torsional Moment	Total Torsional Moment
	w <sub>x</sub> (k)	h <sub>x</sub> (ft)	C <sub>vx</sub>	F <sub>x</sub> (k)	V <sub>x</sub> (k)	M <sub>TA</sub> (ft-k)	e <sub>y</sub> (ft)	M <sub>I</sub> (ft-k)	M <sub>Total</sub> (ft-k)
West Stair Roof	122.81	129.67	0.0103	9.89	9.89	32.15	-	-	32.15
Main Roof	1,821.31	117.67	0.1344	129.44	139.33	420.67	1.75	226.51	647.18
11th	2,461.25	105.67	0.1581	152.28	291.60	494.90	1.75	266.49	761.39
10th	3,121.29	93.67	0.1717	165.33	456.94	537.33	-1.25	-206.67	744.00
9th	2,426.05	84.33	0.1166	112.24	569.18	364.78	-1.25	-140.30	505.08
8th	2,426.05	75	0.1002	96.50	665.68	313.63	-1.25	-120.63	434.26
7th	2,471.77	65.67	0.0860	82.85	748.53	269.27	-1.25	-103.57	372.83
6th	2,471.77	56.33	0.0706	67.99	816.52	220.97	-1.25	-84.99	305.96
5th	2,471.77	47	0.0559	53.84	870.36	174.99	-1.25	-67.30	242.29
4th	2,471.77	37.67	0.0420	40.49	910.85	131.58	-1.25	-50.61	182.18
3rd	2,471.77	28.33	0.0291	28.04	938.89	91.14	-1.25	-35.06	126.20
2nd	3,554.97	19	0.0250	24.11	963.00	78.35	-1.25	-30.13	108.48
<b>TOTALS</b>	<b>28,292.57</b>		<b>1.0000</b>	<b>963.00</b>		<b>3,129.75</b>			

(FIGURE 45) X-Direction Equivalent Lateral Forces & Torsional Moments

<b>Y-DIRECTION (N-S)</b>			<b>SEISMIC LOAD DISTRIBUTION</b>						
			T= 1.138		V <sub>b</sub> = 911				
			k= 1.319						
Floor	Weight	Height	Vertical Distribution Factor	Story Force	Story Shear	Accidental Torsional Moment	COM/COR Eccentricity	Inherent Torsional Moment	Total Torsional Moment
	w <sub>x</sub> (k)	h <sub>x</sub> (ft)	C <sub>vx</sub>	F <sub>x</sub> (k)	V <sub>x</sub> (k)	M <sub>TA</sub> (ft-k)	e <sub>x</sub> (ft)	M <sub>I</sub> (ft-k)	M <sub>Total</sub> (ft-k)
West Stair Roof	122.81	129.67	0.0104	9.51	9.51	126.92	-	-	126.92
Main Roof	1,821.31	117.67	0.1362	124.04	133.55	1,655.99	1.75	217.08	1,873.07
11th	2,461.25	105.67	0.1597	145.46	279.01	1,941.84	1.75	254.55	2,196.39
10th	3,121.29	93.67	0.1727	157.35	436.36	2,100.59	2.58	405.96	2,506.54
9th	2,426.05	84.33	0.1169	106.48	542.83	1,421.47	2.58	274.71	1,696.18
8th	2,426.05	75	0.1001	91.22	634.05	1,217.79	2.58	235.35	1,453.14
7th	2,471.77	65.67	0.0856	78.00	712.05	1,041.31	2.58	201.24	1,242.55
6th	2,471.77	56.33	0.0699	63.71	775.76	850.55	2.58	164.38	1,014.92
5th	2,471.77	47	0.0551	50.18	825.94	669.84	2.58	129.45	799.29
4th	2,471.77	37.67	0.0411	37.47	863.41	500.28	2.58	96.68	596.96
3rd	2,471.77	28.33	0.0282	25.73	889.15	343.55	2.58	66.39	409.94
2nd	3,554.97	19	0.0240	21.85	911.00	291.73	2.58	56.38	348.11
<b>TOTALS</b>	<b>28,292.57</b>		<b>1.0000</b>	<b>911.00</b>		<b>12,161.85</b>			

(FIGURE 46) Y-Direction Equivalent Lateral Forces & Torsional Moments

## TORSION – INHERENT & ACCIDENTAL

Inherent torsion was accounted for by determining the eccentricity of the centers of mass and centers of rigidity from the ETABS model, summarized in Figure 47 below.

<b>COM / COR &amp; Corresponding Eccentricity</b>						
Floor	X <sub>CM</sub> (in)	X <sub>CR</sub> (in)	e <sub>x</sub> (ft)	Y <sub>CM</sub> (in)	Y <sub>CR</sub> (in)	e <sub>y</sub> (ft)
Roof	1554	1533	1.75	433	412	1.75
11th	1554	1533	1.75	433	412	1.75
10th	1564	1533	2.58	397	412	-1.25
9th	1564	1533	2.58	397	412	-1.25
8th	1564	1533	2.58	397	412	-1.25
7th	1564	1533	2.58	397	412	-1.25
6th	1564	1533	2.58	397	412	-1.25
5th	1564	1533	2.58	397	412	-1.25
4th	1564	1533	2.58	397	412	-1.25
3rd	1564	1533	2.58	397	412	-1.25
2nd	1564	1533	2.58	397	412	-1.25

(FIGURE 47) Center of Mass / Center of Rigidity & Corresponding Eccentricity

Due to the rigid diaphragm assumption, ASCE 7-05 also requires consideration of accidental torsion, taken as 5% of the perpendicular dimension to the application of load. Therefore, accidental torsion is greatest in the Y direction. Since the actual eccentricity of centers of mass and rigidity are relatively low, it is not surprising that the total torsional moment is most influenced by accidental torsion. Refer to Figures 45 & 46 above for a summary of moments due to torsion.

## STRUCTURAL IRREGULARITIES

### HORIZONTAL

In order to determine if types 1a and/or 1b (torsion/extreme torsion) existed, the equivalent lateral forces including accidental torsion were applied to the ETABS structure and the resulting story drifts were used to calculate the ratio of max story drift to average story drift. See Appendix D for complete calculations. In the X-direction, the building was found to experience torsion and in the Y-direction extreme torsion. The results are logical based on the geometry of the building. See Figure 48 below for an illustration. In addition, the reentrant corners of the 11<sup>th</sup> Floor and Roof diaphragms are such that type 2 irregularity exists in both directions. Normally, this irregularity would be analyzed by modeling the diaphragms as semi-rigid in those areas; however, since the focus of this thesis is more on shear wall design rather than diaphragm design, modeling and calculations for this condition have been omitted. By inspection, horizontal irregularity types 3 (diaphragm discontinuity), 4 (out-of-plane offsets), and 5 (nonparallel systems) can be eliminated.

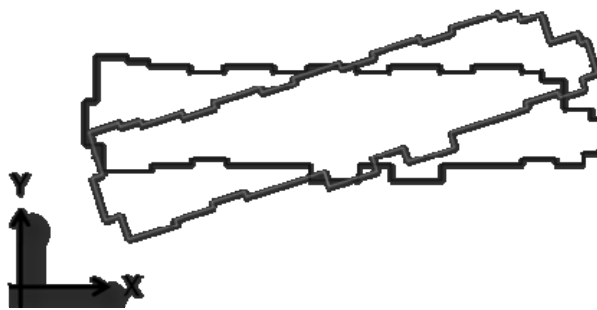

(FIGURE 48) Torsional Irregularity Illustration

## VERTICAL

By inspection, none of the vertical irregularity types exist in this building; however, in order to verify this for those irregularities that were not as obvious, calculations were performed for both type 1a/1b (soft story/extreme soft story), as well as type 2 (mass irregularity). See Appendix D for these calculations.

The presence of these irregularities makes it necessary to take further steps to account for them. Since type 1a/1b exists, the code requires calculation of an amplification factor to be applied to the accidental torsional moments. Although they were calculated, the values were less than one, and therefore, a value of one was used and the originally calculated accidental torsional moments did not change. Figures 49 & 50 below summarize the amplification factors and the ETABS displacements used to find them.

<b>Accidental Torsion Amplification Factors (X-Direction)</b>				
Floor	Maximum Displacement	Average of Displacements at X Extremities	Calculated Torsional Amplification Factor	Actual Torsional Amplification Factor to use based on limitations
	$\Delta_{max,X}$ (in.)	$\Delta_{avg,X}$ (in.)	$A_x$	$1 \leq A_x \leq 3$
West Stair Roof	1.573	1.527	0.74	1
Main Roof	1.440	1.400	0.73	1
11th	1.150	1.156	0.69	1
10th	0.959	0.953	0.70	1
9th	0.823	0.818	0.70	1
8th	0.670	0.666	0.70	1
7th	0.543	0.540	0.70	1
6th	0.423	0.421	0.70	1
5th	0.313	0.311	0.70	1
4th	0.214	0.213	0.70	1
3rd	0.131	0.130	0.71	1
2nd	0.065	0.065	0.69	1

(FIGURE 49) X-Direction Accidental Torsion Amplification Factors

<b>Accidental Torsion Amplification Factors (Y-Direction)</b>				
Floor	Maximum Displacement	Average of Displacements at Y Extremities	Calculated Torsional Amplification Factor	Actual Torsional Amplification Factor to use based on limitations
	$\Delta_{max,Y}$ (in.)	$\Delta_{avg,Y}$ (in.)	$A_y$	$1 \leq A_y \leq 3$
West Stair Roof	2.176	1.824	0.99	1
Main Roof	2.320	2.247	0.74	1
11th	1.967	1.905	0.74	1
10th	1.612	1.562	0.74	1
9th	1.379	1.336	0.74	1
8th	1.117	1.083	0.74	1
7th	0.901	0.874	0.74	1
6th	0.698	0.677	0.74	1
5th	0.512	0.496	0.74	1
4th	0.347	0.336	0.74	1
3rd	0.208	0.202	0.74	1
2nd	0.100	0.097	0.74	1

(FIGURE 50) Y-Direction Accidental Torsion Amplification Factors

In addition to this requirement, the code also mandates that for SDC-D with a type 1 horizontal irregularity, a Modal Response Spectrum Analysis (MRSA) is required in lieu of the Equivalent Lateral Force Procedure (ELFP). It is important to note that a number of assumptions were made along the way, as discussed, which make a more exhaustive and detailed analysis impractical for the purposes of developing a general prototype design. The ELFP is generally considered adequate for certain types of buildings and suited for preliminary design of other irregular structures. The goals of this thesis were aimed more toward developing the actual preliminary designs of shear walls under an increased lateral loading, and assessing their feasibility for use as a prototype design. Further, it will be shown in subsequent sections of this report that even with the severely increased seismic loads, wind is still controlling the design in the Y-direction due to the size of the façade in that direction.

## RELATIVE STIFFNESS OF SHEAR WALLS

Relative stiffness of shear walls was determined by applying an arbitrary lateral load to the structure in ETABS and extracting the percentage of total shear taken by each on a typical floor. The results are shown in Figure 51 below. (Refer to Figure 52 for layout & numbering of shear walls). Based on the relative size of each and the influence of the surrounding diaphragms, these results were deemed accurate. For example, it was expected that Shear Walls 2 & 11 see very little load because they are located on the outside face of a stairwell, where the diaphragm is discontinued. Likewise, the largest shear wall (SW-4) is taking a significant amount of the load, as are the other large shear walls in the X-direction.

<b>Relative Stiffness of Shear Walls</b>		
	Shear Wall	% Lateral Resistance Based on Shear
X-Direction Loading	SW-2	1
	SW-4	52
	SW-5	1
	SW-7	1
	SW-9	28
	SW-11	1
	SW-13	16
Y-Direction Loading	SW-3	1
	SW-1	28
	SW-6	27
	SW-8	7
	SW-14	7
	SW-12	29
	SW-10	1

(FIGURE 51) Relative Stiffness & Lateral Force Distribution in Shear Walls

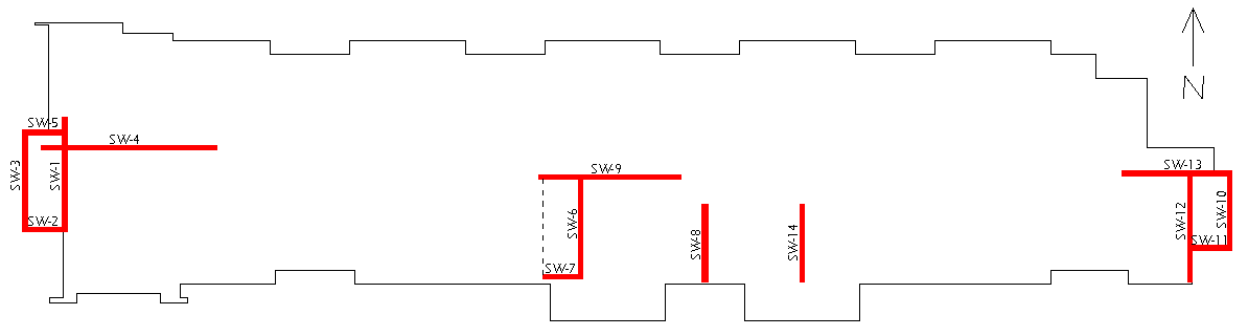

(FIGURE 52) Shear Wall Layout

## DESIGN LOADS ON SHEAR WALLS FOR RE-DESIGN

After applying all loads including torsion to the structure in ETABS, the critical shears and moments were extracted from the output for use in the re-design of shear walls. Axial loads were manually calculated and included for the design. See Figure 53 below. Although Shear Walls 3 & 10 realistically will not experience as much load as is assigned here, due to the fact that the diaphragm is not continuous to these walls, the author has conservatively assigned load to them. The loads on Shear Walls 1 & 12 were then increased to account for the fact that these walls will likely be responsible for loads to both of these walls in the Y direction. This method was utilized to avoid errors in ETABS resulting from openings in the diaphragm. The goal of the re-design was to maintain all existing shear wall locations, adjusting only their size and reinforcement to accommodate the increased loading. Minimal impact on the overall architecture and design of the building was achieved this way.

<b>Critical Loads at Base of Shear Walls</b>					
	Shear Wall	Controlling Load Combination	Axial	Shear	Moment
			P <sub>u</sub> (kips)	V <sub>u</sub> (kips)	M <sub>u</sub> (ft-k)
X-Direction Loading	SW-2	(5)	235	12	476
	SW-4	(5)	2,169	640	51,115
	SW-5	(5)	175	13	509
	SW-7	(5)	216	12	481
	SW-9	(5)	1,468	343	23,980
	SW-11	(5)	235	16	678
	SW-13	(5)	722	191	11,752
Y-Direction Loading	SW-3	(4)	532	15	10,980
	SW-1	(4)	1,701	413	15,350
	SW-6	(4)	2,056	399	14,626
	SW-8	(4)	689	103	4,998
	SW-14	(4)	689	108	6,117
	SW-12	(4)	749	327	24,021
	SW-10	(4)	424	15	7,306

Controlling Load Combinations:

(4)  $1.2D + 1.6W + L + 0.5(L_r \text{ or } S)$

(5)  $(1.2 + 0.2S_{DS})D + PE + L + 0.2S$

(FIGURE 53) Critical Loads at Base of Shear Walls

For all shear walls in the Y-Direction, as previously mentioned, critical loads are governed by the wind loading. This is not surprising considering the sizeable façade facing this direction. However, in the X-Direction, the increased seismic loading prevails as the critical case for all shear walls. Although not always true, here, the unfactored (& factored based on the relative factors applied to each) base shear corresponded to the critical loads in each direction. See Figure 54 below for a comparison.



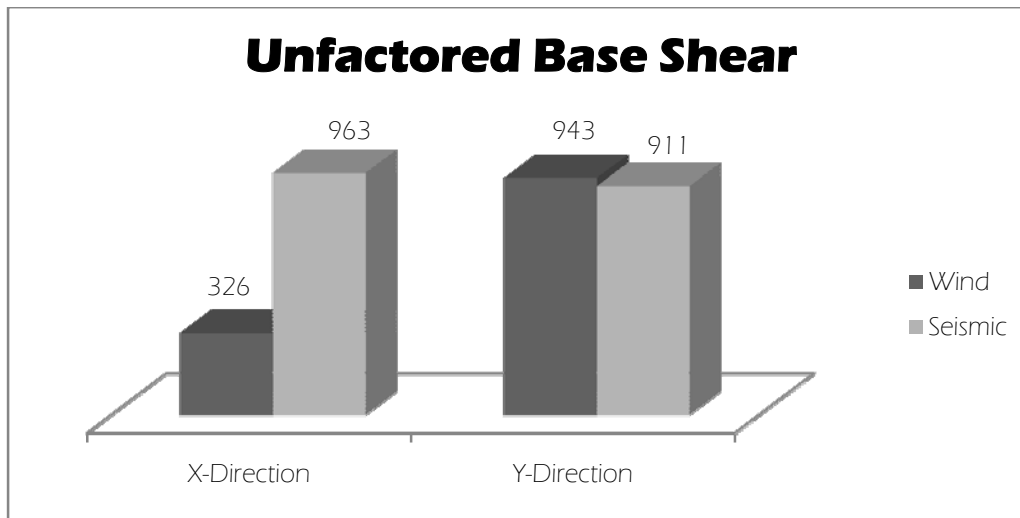

(FIGURE 54) Unfactored Base Shears – Wind vs. Seismic

#### SHEAR WALL RE-DESIGN

Each shear wall was re-designed for the new critical loads. Chapter 21 of ACI 318-08 was used to ensure that the new designs satisfy requirements for the more severe seismic loads. The provisions of this chapter that altered the original design the most were the requirements for boundary elements, used to increase strength and ductility in special reinforced concrete shear walls. Where required, these boundary elements were designed to lie entirely within the original thickness of the wall as much as possible, so as not to affect the architectural design. However, in many cases, this was not possible, and flanges protruded a maximum of 6 inches on each side of the wall. It was assumed that this minimal additional thickness would not impose drastic changes to the architectural plans. Chord reinforcing increased significantly due to the increased moments seen by each shear wall. Transverse and longitudinal reinforcing for shear and flexure was not altered significantly from the original design, largely because it is more practical to maintain a typical layout (#4 @ 12" EF, EW) of said reinforcement that meets the most critical demands, and is conservative for all other lesser demands. However, Shear Wall 4 required an increase to #9 @ 12" EF, EW to be adequate for the significant amount of shear taken by this wall (640 kips). A comparison of the newly designed shear walls and the original design is summarized in Figures 55 & 56 below. For complete calculations related to shear wall design, refer to Appendix D. Only those significant aspects, such as wall thickness, chord/boundary element size and

reinforcement are given, in order to illustrate those aspects which caused an increase in material for the prototype. (Note: Where the term "NONE REQ'D" is used, this refers to special boundary elements only; chord reinforcement still applies and is given.)

X-Direction: Shear Wall Design Comparison							
Shear Wall	Wall Length (ft)	Wall Thickness (in)	Boundary Elements / Chords		% Increase - Materials		
			Original Design	Prototype Re-Design	Conc.	Chord Reinf.	Ties
SW-2	10	12	NONE REQ'D ; CHORDS: (8) #8 ; (4) #4 TIES @ 12" VERT. SPACING	NONE REQ'D ; CHORDS: (8) #8 ; (4) #5 TIES @ 6" VERT. SPACING	0	0	110
SW-4	42	12	NONE REQ'D ; CHORDS: (16) #9 ; (5) #4 TIES @ 12" VERT. SPACING	24" x 40" (16) #10 ; (5) #5 TIES @ 6" VERT. SPACING	16	27	155
SW-5	10	12	NONE REQ'D ; CHORDS: (10) #6 ; (5) #4 TIES @ 12" VERT. SPACING	NONE REQ'D ; CHORDS: (8) #8 ; (4) #5 TIES @ 6" VERT. SPACING	0	44	48
SW-7	9	12	NONE REQ'D ; CHORDS: (8) #8 ; (4) #4 TIES @ 12" VERT. SPACING	NONE REQ'D ; CHORDS: (10) #8 ; (4) #5 TIES @ 6" VERT. SPACING	0	25	110
SW-9	31	12	NONE REQ'D ; CHORDS: (12) #7 ; (5) #4 TIES @ 12" VERT. SPACING	18" x 28" (14) #9 ; (6) #4 TIES @ 4" VERT. SPACING	8	94	220
SW-11	10	12	NONE REQ'D ; CHORDS: (6) #7 ; (3) #4 TIES @ 12" VERT. SPACING	NONE REQ'D ; CHORDS: (8) #8 ; (4) #5 TIES @ 6" VERT. SPACING	0	76	212
SW-13	24	12	NONE REQ'D ; CHORDS: (10) #8 ; (5) #4 TIES @ 12" VERT. SPACING	12" x 22" (12) #8 ; (6) #4 TIES @ 3" VERT. SPACING	0	20	320

(FIGURE 55) X-Direction Shear Wall Re-Design Summary & Comparison

Y-Direction: Shear Wall Design Comparison							
Shear Wall	Wall Length (ft)	Wall Thickness (in)	Boundary Elements / Chords		% Increase - Materials		
			Original Design	Prototype Re-Design	Conc.	Chord Reinf.	Ties
SW-3	22.5	12	NONE REQ'D ; CHORDS: (6) #7 ; (3) #4 TIES @ 12" VERT. SPACING	<b>12" x 18"</b> (12) #8 ; (5) #4 TIES @ 3" VERT. SPACING	0	163	367
SW-1	25.5	12	NONE REQ'D ; CHORDS: (8) #10 ; (4) #4 TIES @ 12" VERT. SPACING	<b>18" x 30"</b> (14) #8 ; (6) #4 TIES @ 4" VERT. SPACING	10	9	250
SW-6	23.5	12	NONE REQ'D ; CHORDS: (10) #8 ; (5) #4 TIES @ 12" VERT. SPACING	<b>18" x 34"</b> (14) #8 ; (6) #4 TIES @ 4" VERT. SPACING	12	40	220
SW-8	17	12	NONE REQ'D ; CHORDS: (12) #10 ; (5) #4 TIES @ 12" VERT. SPACING	<b>NONE REQ'D ;</b> CHORDS: (14) #10 ; (5) #4 TIES @ 6" VERT. SPACING	0	17	100
SW-14	17	14	NONE REQ'D ; CHORDS: (12) #10 ; (5) #4 TIES @ 12" VERT. SPACING	<b>NONE REQ'D ;</b> CHORDS: (14) #10 ; (5) #4 TIES @ 6" VERT. SPACING	0	17	100
SW-12	23.5	12	NONE REQ'D ; CHORDS: (12) #8 ; (5) #4 TIES @ 12" VERT. SPACING	<b>12" x 34"</b> (14) #10 ; (6) #5 TIES @ 3" VERT. SPACING	0	89	386
SW-10	24	12	NONE REQ'D ; CHORDS: (10) #8 ; (5) #4 TIES @ 12" VERT. SPACING	<b>12" x 18"</b> (10) #8 ; (5) #4 TIES @ 3" VERT. SPACING	0	0	300

(FIGURE 56) Y-Direction Shear Wall Re-Design Summary & Comparison

In the X-Direction, it is clear that Shear Walls 4, 9, & 13 are mainly responsible for lateral loads. Shear Wall 4, having the largest demand, is the only wall in which it was necessary to protrude the maximum of 6 inches. See Figure 57 below for a detailed illustration for the

design of this wall. In the Y-Direction, a more even distribution of lateral loads is realized by the need for boundary elements on most walls oriented in this direction. Wherever a 12" dimension was possible for boundary elements, it was utilized, as can be seen in Shear Walls 13, 3, 12, & 10. For sake of comparison, the percentages of material increases resulting from the re-design are listed in the columns to the right for concrete, chord reinforcement, and tie reinforcement. From these results, it is apparent that the most notable increase was in the tie reinforcement. This is a logical result since increased confinement is known to have a positive impact on performance during earthquakes. In general, concrete volumes only increased in those walls requiring protruding boundary elements and in all cases, chord reinforcement also increased slightly to resist the increased overturning moments.

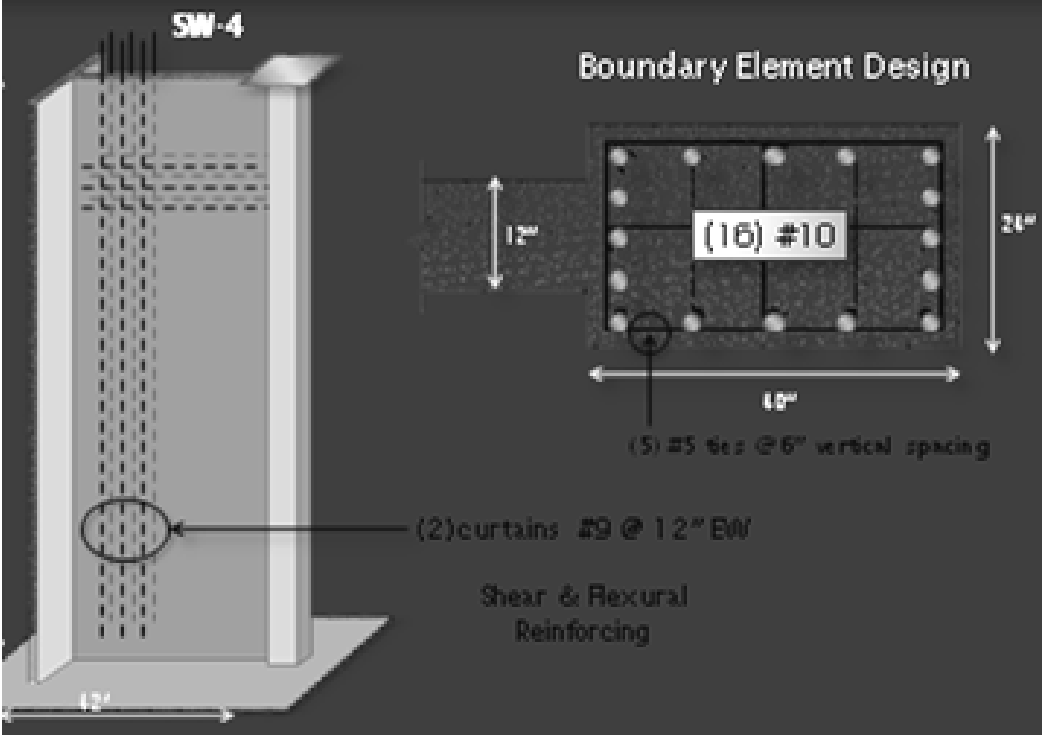

(FIGURE 57) Shear Wall 4 Re-Design Illustration

## OVERTURNING MOMENT & FOUNDATIONS

As was previously determined by analysis, the weight of this building is considerably more than adequate to resist the overturning moment associated with the prescribed lateral load conditions. Furthermore, assuming the same foundation systems used for the Norfolk, VA location were used for the prototype, the precast concrete piles that form the foundations for the Residence Inn inherently are capable of resisting up to 70 kips of uplift each. Therefore, it is safe to assume that overturning moments will not be critical for this building. Due to the prototypical approach to design, foundations would need to be assessed on a case-by-case basis and therefore, are not part of the scope of this thesis.

## DRIFT/DEFLECTION CHECK

After the shear walls were re-designed, the ETABS model was modified to check that the design meets the acceptable limits for drift and deflection. See Figure 58 for results. As can be seen, the re-design is well within the prescribed limits, as previously defined. Therefore, modifications to the design were unnecessary.

<b>Story Drift &amp; Building Deflection</b>							
Story	Story Height (ft)	Story Drift (in.)	Allowable Story Drift	Story Drift OK?	Building Deflection (in.)	Acceptable Building Deflection (h/400) (in.)	Building Deflection OK?
Roof	12	0.43	2.88	OK	3.55	3.89	OK
11th	12	0.41	2.88	OK	3.12	3.53	OK
10th	12	0.39	2.88	OK	2.71	3.17	OK
9th	9.33	0.36	2.24	OK	2.32	2.81	OK
8th	9.33	0.32	2.24	OK	1.96	2.53	OK
7th	9.33	0.29	2.24	OK	1.64	2.25	OK
6th	9.33	0.27	2.24	OK	1.35	1.97	OK
5th	9.33	0.26	2.24	OK	1.08	1.69	OK
4th	9.33	0.23	2.24	OK	0.82	1.41	OK
3rd	9.33	0.19	2.24	OK	0.59	1.13	OK
2nd	9.33	0.17	2.24	OK	0.40	0.85	OK
1st	19	0.23	4.56	OK	0.23	0.57	OK

(FIGURE 58) Story Drift & Building Deflection Summary

## PROTOTYPE EVALUATION

In order to evaluate the feasibility of a prototype structural design for this building, both the cost for the increase in materials for strengthening lateral force resisting systems and the cost for engineering services was analyzed. Associated material cost increases for shear walls were obtained using data from RS Means Building Construction Cost Data. See Figure 59 below for a summary. Unit costs for concrete are for material only, since labor would not change significantly with the small amount of increase in concrete volume. Reinforcement unit costs do, however, incorporate the cost of materials and labor to account for the additional time that would be necessary to bend and place the large number of additional bars and ties. None of these values has been adjusted for location, which means the results and conclusions drawn here are unspecific to location; however they are used for sake of comparison. Based on these calculations and assumptions, the total estimated additional cost for 'over-designing' the lateral force resisting shear walls from a location like Norfolk, VA to a more severe seismic demand, is approximately \$92,000. With the total cost of the project being approximately \$22 million, this increase only amounts to a mere 0.42% of the total project cost, and a 2.1% cost increase for the structure alone.

Engineering services for the project are estimated at approximately \$154,000, or 0.7% of the total project cost. Obviously, it would be impossible to completely eliminate the need for some engineering, based on the fact that some of the assumptions made, such as soil conditions and exposure, may be more critical for some geographic locations. Foundation systems especially would need to be specifically engineered for the actual site. However, assuming that the cost of **structural engineering services** was reduced by two thirds by using the prototype design, a **savings** of approximately **\$11,500** (or 0.05% of the total project cost) could be realized for each structural engineering reproduction. Relative to the overall cost of a building such as this, Marriott may choose not to take advantage of these savings simply because their dedication to the environment would be compromised by the 44 tons of steel that would be added to the structure for a location like Norfolk, VA unnecessarily. Ultimately, a decision like this would need to be evaluated further for implications such as this; however, the results based on these assumptions have proven savings by utilizing a 'pre-engineered' structural design.

Shear Walls	Prototype Associated Material Cost Increases			
	Concrete	Chord Reinf.	Tie Reinf.	TOTALS
X-Direction	\$4,795	\$15,152	\$23,439	\$43,386
Y-Direction	\$2,842	\$18,758	\$26,520	\$48,120
<b>TOTALS</b>	<b>\$7,637</b>	<b>\$33,910</b>	<b>\$49,959</b>	<b>\$91,506</b>

(FIGURE 59) Prototype Associated Material Cost Increases for Shear Walls

## LATERAL SYSTEMS CONCLUSIONS

Based on the results of the shear wall re-design, it was found that in general, special reinforced concrete shear walls require a special boundary element design, which, in many cases, causes a significant increase in material, particularly reinforcement. Although architecturally the re-design has little effect, the hidden increase in strength and ductility directly correlates with an increase in cost of structural systems of approximately 2.1% or \$91,500. Assuming that structural engineering costs are reduced by two thirds by taking advantage of a design that is, for the most part, 'pre-engineered,' it is estimated that for each new reproduction of the prototype, a savings of \$11,500 can be realized. For obvious reasons, some structural engineering would be required that takes into consideration the particular site for which the prototype would be located for design of foundations and checks for more critical conditions than were assumed by the prototype. Since the cost savings realized would be small relative to the total cost of the building, moral consideration must play a role in the decision of whether or not to consider using the 'over-designed' prototype for less critical locations, as there is a significant associated increase in the use of non-renewable resources and energy to produce the excess steel reinforcement. Otherwise, this exercise proved to be a valuable one, where experience in shear wall design for high seismic loading was obtained. The possibility of a prototype structure for the *Executive Residence Inn* remains and would certainly be valuable to a company such as Marriott, to whom economy can be realized.

# APPENDIX A: ARCHITECTURAL BREADTH

## CODE ANALYSIS

IBC 2006	RESIDENCE INN	KMR	1/3																		
<p>OCCUPANCY :</p> <ul style="list-style-type: none"> <li>→ BUSINESS GROUP B</li> </ul> <p>CONSTRUCTION TYPE : 1 B</p> <ul style="list-style-type: none"> <li>• 2 HR FIRE RATING, REQ'D FOR STRUCTURAL FRAME, BEARING WALLS, &amp; FLOOR CONSTRUCTION</li> <li>(ALSO ROOF CONSTRUCTION B/C OCCUPIED GREEN SPACE)</li> </ul> <p>OCCUPANCY LOAD : (OL) [13,300 GSF EA FLR]</p> <ul style="list-style-type: none"> <li>→ BUSINESS AREAS - 100 GSF/OCCUPANT → 133 OCC'S</li> <li>→ RESIDENTIAL - 200 " " → 67 OCC'S</li> <li>→ OUTDOOR AREAS (ASSIGNED BY BLDG. OFFICIAL BASED ON USE)</li> </ul> <p>EGRESS WIDTH :</p> <table border="0" data-bbox="438 1176 1234 1344"> <tr> <td>• W/ SPRINKLER (BUS. AREAS) →</td> <td>STAIRWAYS <math>0.2 \times OL</math> <math>= 26.6"</math></td> <td>OTHER <math>0.15 \times OL</math> <math>= 20"</math></td> </tr> <tr> <td colspan="3">• MIN. CORRIDOR WIDTH = <span style="border: 1px solid black; padding: 2px;">44"</span> GOVERNS</td> </tr> </table> <p>DEAD-ENDS :</p> <ul style="list-style-type: none"> <li>• GROUP B W/ <sup>AUTO</sup> SPRINKLER → 50' MAX</li> </ul> <p>MIN. # EXITS FOR OCC. LOAD :</p> <table border="0" data-bbox="357 1533 1169 1659"> <tr> <td></td> <td style="text-align: center;">OL</td> <td style="text-align: center;">MIN # EXITS</td> </tr> <tr> <td>1-500</td> <td></td> <td style="text-align: center;"><span style="border: 1px solid black; border-radius: 50%; padding: 2px;">2</span></td> </tr> <tr> <td>501-1,000</td> <td></td> <td style="text-align: center;">3</td> </tr> <tr> <td>&gt;1000</td> <td></td> <td style="text-align: center;">4</td> </tr> </table> <p>EXIT ACCESS TRAVEL DIST. :</p> <ul style="list-style-type: none"> <li>• OCC. B → 300' MAX (W/SPRINKLER; MEAS. FROM MOST REMOTE LOCATION)</li> </ul>				• W/ SPRINKLER (BUS. AREAS) →	STAIRWAYS $0.2 \times OL$ $= 26.6"$	OTHER $0.15 \times OL$ $= 20"$	• MIN. CORRIDOR WIDTH = <span style="border: 1px solid black; padding: 2px;">44"</span> GOVERNS				OL	MIN # EXITS	1-500		<span style="border: 1px solid black; border-radius: 50%; padding: 2px;">2</span>	501-1,000		3	>1000		4
• W/ SPRINKLER (BUS. AREAS) →	STAIRWAYS $0.2 \times OL$ $= 26.6"$	OTHER $0.15 \times OL$ $= 20"$																			
• MIN. CORRIDOR WIDTH = <span style="border: 1px solid black; padding: 2px;">44"</span> GOVERNS																					
	OL	MIN # EXITS																			
1-500		<span style="border: 1px solid black; border-radius: 50%; padding: 2px;">2</span>																			
501-1,000		3																			
>1000		4																			



IBC 2006	RESIDENCE INN	KMR	2/3
<u>RESTROOMS</u>			
• WATER CLOSETS -	1 PER 25 OL (1 <sup>st</sup> 50) 1 PER 50 (REST)	} MALE & FEMALE	
	↳ (4) TOTAL REQ'D BASED ON OCC. OF 133		
• LAVATORIES -	1 PER 40 (1 <sup>st</sup> 80) 1 PER 80 (REST)	→ (3) REQ'D	
• DRINKING FTNS -	1 PER 100	→ (2) REQ'D	
• SVC. SINK -	1 REQ'D		

ASCE 7-05	RESIDENCE INN	KMR	3/3
<u>REQ'D LIVE LOADS</u>			
OFFICES	50 PSF	/ 2000* CONC.	
CORRIDORS ABOVE 1 <sup>st</sup> FLR.	80 PSF	/ 2000* CONC.	
ROOFS W/ GARDENS	100 PSF		
BALCONIES - EXTERIOR	100 PSF		
<u>DEAD LOADS</u>			
TYPICAL OFFICES /CORRIDORS (SDL)	15 PSF		
GREEN ROOF			
GREEN-GRID® MODULAR SYSTEM	35+ PSF (8" DEEP MODULE)		
	41.6 PSF (8" WATER FEATURE)		
	7.5 PSF (PAVERS)		
	SAY ~ 45 PSF		
SELF-WT OF SLAB = $150 \text{ PCF} \times \frac{t}{12}$	8" → 100 PSF		
	10" → 125 PSF		

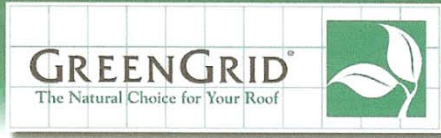

The PREMIER Green Roof System

# Specifications Summary

**ELEMENT**

**DESCRIPTION**

**Module sizes (nominal)**

2 ft x 2 ft x 2.5 in (~ 61 cm x 61 cm x 6 cm)  
 2 ft x 2 ft x 4 in (~ 61 cm x 61 cm x 10 cm)  
 2 ft x 4 ft x 4 in (~ 61 cm x 122 cm x 10 cm)  
 40 in x 40 in x 4 in (~ 102 x 102 cm x 10 cm)  
 2 ft x 2 ft x 2.8 ft x 4 in  
 (~ 61 cm x 61 cm x 85 cm x 10 cm) (triangle)  
 2 ft x 2 ft x 8 in (~ 61 cm x 61 cm x 20 cm)  
 2 ft x 4 ft x 8 in (~ 61 cm x 122 cm x 20 cm)



**Depth of modules (three depths)**

2.5 in (~ 6.4 cm), 4 in (~ 10 cm), and 8 in (~ 20 cm) (nominal)

**Weight of planted modules (when wet)**

2.5-in depth – Approx. 11-13 lb/ft<sup>2</sup> (53.7 – 63.5 kg/m<sup>2</sup>)  
 4-in depth – Approx. 18-22 lb/ft<sup>2</sup> (87.9 – 107.4 kg/m<sup>2</sup>)  
 8-in depth – Approx. 35+ lb/ft<sup>2</sup> (170.8+ kg/m<sup>2</sup>)  
*(Weight may vary based on requirements for project-specific vegetation selections and variations in regional materials incorporated in growth media.)*

**Module material**

100% post-industrial recycled High Molecular Weight Polyethylene. Protected with UV inhibitors and stabilizers.  
 – 150 mil (2.5 and 4 in)  
 – 200 mil (8 in)

**Module drainage clearance above roof**

0.5 in (1.3 cm)

**Color of modules**

Black

**Drainage/root resistance medium**

3-oz spunbonded polypropylene geotextile

**Growth media**

Proprietary mixture consisting of organic and inorganic material

**Slip sheet protection fabric**

6-oz non-woven geotextile slip sheet. *(Installation of slip sheet between GreenGrid® modules and roof surface is recommended.)*

**Vegetation**

Drought-resistant groundcovers, natives, perennials, and/or ornamental grasses specifically selected for climate, hardiness zone, color, and size.

**OPTIONAL ELEMENTS**

**Paver size**

2 ft x 2 ft (~ 61 cm x 61 cm) *(various depths available)*

**Paver material**

100% recycled rubber

**Paver colors (standard)**

Forest green, charcoal, brick red, black, and blue  
*(other, non-standard colors available)*

**Paver weight**

7.5 lb/ft<sup>2</sup>, based on 1.75-in depth (36.8 kg/m<sup>2</sup>, based on 4.5-cm depth)

**Edge treatments**

Aluminum or steel, available in various colors and designs.

GreenGrid and ABC Supply Co. are trademarks of American Builders & Contractors Supply Co., Inc. The GreenGrid® System is a proprietary technology of ABC Supply. U.S. and International patents pending. WESTON® is the exclusive licensee of the GreenGrid® System in the U.S.



# APPENDIX B: LIGHTING BREADTH

## LUMEN METHOD CALCULATIONS

LIGHTING BREADTH	EXECUTIVE RESIDENCE INN	KMR	1/2
<p>TARGET ILLUMINANCE = 30 fc (Ill. Cat. D) ... 2000 IESNA HANDBOOK                      → LUMEN METHOD</p>			
<p>ASSUMING RECT.                      WP HT = 2.5'                      CLG. HT = 12'</p> <p>CAVITY RATIO: (ASSUMING FLUSH MOUNTED FIXTURES)  <math display="block">RCR = \frac{5(9.5')(19+21.5)}{(19 \times 21.5)}</math> <math display="block">= 4.71</math></p> <p><math display="block">FCR = \frac{5(2.5)(19+21.5)}{(19 \times 21.5)}</math> <math display="block">= \underline{1.24}</math></p>			
<p>REFLECTANCES: CLG WALLS FLR 80/60/30                      WINDOW: 0.20 = 20%</p> <p><math>\rho_{fc} = 28\%</math>  <math>\rho_c = 80\%</math></p> <p><math display="block">\rho_w = \frac{19(20) + (19 + 2(21.5))(60)}{2(19 + 21.5)} = 50.6\% \approx 50\%</math></p> <p>CU (80 / 50 / 20) <small>(TBL ASSUMES)</small></p> <p>FROM SPEC (AVSM 1x4 LINEAR FL. T5)</p> <p><math display="block">\frac{RCR}{4} \frac{45}{5} \rightarrow \frac{4.71}{5} \frac{45}{40} = \underline{41.5 = CU}</math></p> <p>CORRECTION FOR <math>\rho_{fc} = 28\%</math>                      for <math>\rho_{30\%} \rightarrow</math> factor is 1.04</p> <p><math display="block">\frac{1.0}{1.032} \frac{20\%}{28\%} \frac{20\%}{30\%} \quad 1.032(41.5) = \boxed{42.8}</math></p>			

LLF'S

BALLAST FACTOR = 1.0 (SEE PRODUCT SPEC FOR BALLAST SELECT)

LBO = 1.0

RSDD = 0.932

12 MOS. CLEANING INTERVALS  
CLEAN ENVIRON.  
SEMI-DIRECT  
% EXPECTED DIRT DEPREC. = 10%

LLD = 0.95

418/400 MEAN/INITIAL

LDD = 0.94

CLASSIFICATION II : ≥ 15% UPLIGHT  
TOP & BOT. OPENINGS

$LLF = (1.0)(1.0)(0.932)(0.95)(0.94) = \underline{0.832}$

# LUMINAIRES =  $\frac{(30 \text{ FC})(19' \times 21.5')}{(1)(4400)(0.428)(0.832)} = 7.8 \sim \boxed{8}$

POWER DENSITY =  $8(54) / (19 \times 21.5) = 1.06 \text{ W/ft}^2 \quad \checkmark \text{OK}$

MAX SPACING:

$SC_{0^\circ} = 1.2(9.5') = 11.4' \text{ ALONG}$

$SC_{90^\circ} = 1.38(9.5') = 13.1' \perp$

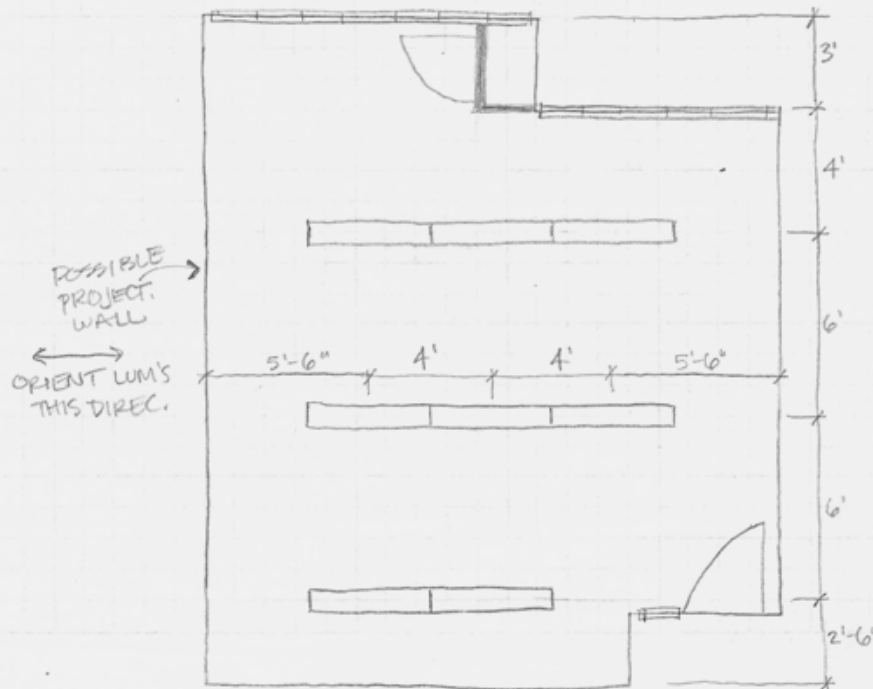

Direct/Indirect Lighting

# Avante®

Surface/Suspended



Intended Use

1x2 – ideal for general or task lighting in alcoves, narrow corridors and small spaces. 1x4 – suitable for general area or task-specific lighting in both new construction and remodeling. Especially suited for conference rooms, reception areas, health care institutions, education facilities and offices.

Features

Contemporary, low-profile construction, suitable for surface and suspended mounting, providing direct or semi-direct light distribution.

Rugged steel housing in 2', 4' or 8' field-joinable units for continuous rows.

Injection molded joiners with snap-on finished ends.

Available with popular Avante® 1x4 shieldings – MDR, MDM and SBL.

Reflectors finished with high-reflectance, matte-white polyester powder paint for uniform light distribution.

Reflector option includes painted white steel reflectors with or without semi-perforated option for uplight, or diffuse aluminum stepped reflector (ASR).

TSHO or T8 lamping configurations available.

Listings

UL Listed (standard). CSA Certified (standard; except for 347V – see Options).

Ordering Information

Example: AVSM 2 32 MDR DLS MVOLT GEB10RS

Series	Lamp type	Diffuser	Voltage	Options
AVSM 1' wide, 2' and 4' long	17 17W T8 (24") 32 32W T8 (48")	MDR Metal diffuser, round holes	MVOLT 347 Others available; consult factory.	GEB10RS T8 electronic ballast, ≤10% THD, instant start GEB10PS T5 electronic ballast, ≤10% THD, program start GEB10RS T8 electronic ballast, ≤10% THD, rapid start
TAVSM 1' wide, 8' long	14TS 14W T5 (22") 28TS 28W T5 (46") 24TSHO 24W T5 (22") CF40 40W TTS (24") CF50 50W TTS (24") 54TSHO 54W T5 (46")	MDM Metal diffuser, mini slots SBL Straight blade louver, round holes Others available; consult factory.		ALG Acrylic litter guard GLR Internal fast blow fuse <sup>3</sup> CSA CSA Certified (347 only)
	Number of loss lamps in cross section 1 2 <sup>1</sup> Not included.	Light distribution ULR Uplight, round hole, perforated band <sup>2</sup> DLS Downlight, solid		Reflector options ASR Aluminum stepped reflector <sup>4</sup>

- NOTES:  
 1 Available with straight-tube T5 or T8 lamps only.  
 2 For suspended mounting only.  
 3 Must specify 120 or 277 voltage.  
 4 Not available with ULR.

	Ballast/Lamp Compatibility						
	17	32	14TS	28TS	24TSHO	CF40	54TSHO
GEB10RS	■						
GEB10PS			■	■	■		■
GEB10RS	■	■					■

Dimensions shown in inches (centimeters) unless otherwise noted.

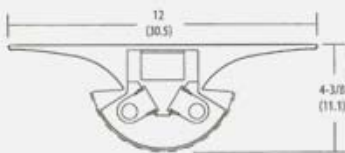

Availability and Dimensions				
Nominal size	Series	Number of lamps	Lamp type	Length
1'x2'	AVSM	1, 2	17, 14TS, 24TSHO	2'
		1	CF40, CF50	2'
1'x4'	AVSM	1, 2	32, 28TS, 54TSHO	4'
1'x8'	TAVSM	1, 2	32, 28TS, 54TSHO	8'



www.lithonia.com, keyword: AVSM

PSG9

## Surface Avante® Availability Matrix

### Options for AVSM

		AVSM 1x2	AVSM 1x4	AVSM 1x8
GLR	Internal fast blow fuse	■	■	■
LP	Lamped; specify lamp type and color	■	■	■
EL	Emergency battery pack (nominal 300 lumens, see Life Safety section)	■	■	■
ELSS	Emergency battery pack for TS/TSHD (nominal 390-700 lumens, see Life Safety section)	■	■	■
MDR	Metal diffuser, round holes	■	■	■
MDM	Metal diffuser, mini-slots	■	■	■
SBL	Straight blade louver	■	■	■
ALG	Acrylic litter guard	■	■	■

### Accessories for AVSM

		AVSM 1x2	AVSM 1x4	AVSM 1x8
AVAC	For grid mounting, adjustable cables non-feed individual or row fixtures	■	■	■
AVACF	For grid mounting, adjustable cables feed individual fixtures (18ga SFT)	■	■	■
AVACF_12AWG	For grid mounting, adjustable cables feed row fixtures (12 ga SFT)	■	■	■
AVAC_DWL	For j-box or dry wall mounting, adjustable cables non-feed individual or row fixtures	■	■	■
AVACF_DWL	For j-box or dry wall mounting, adjustable cables feed individual fixtures (18 ga SFT)	■	■	■
AVACF_DWL12AWG	For j-box or dry wall mounting, adjustable cables feed row fixtures (12 ga SFT)	■	■	■
SCY	For j-box or dry wall mounting, stem mount non-feed or feed individual or row fixtures	■	■	■

Note: Fixtures supplied with 15/74" grid mounting hardware standard.

### Lengths for AVSM accessories above (example: AVACF30)

		AVSM 1x2	AVSM 1x4	AVSM 1x8
30	3" to 30" below ceiling adjustable cable mounting	■	■	■
60	30" to 60" below ceiling adjustable cable mounting	■	■	■
96	60" to 96" below ceiling adjustable cable mounting	■	■	■
144	96" to 144" below ceiling adjustable cable mounting	■	■	■
SCY4	4" below ceiling stem mounting	■	■	■

### NOTES:

- Cannot be field installed.

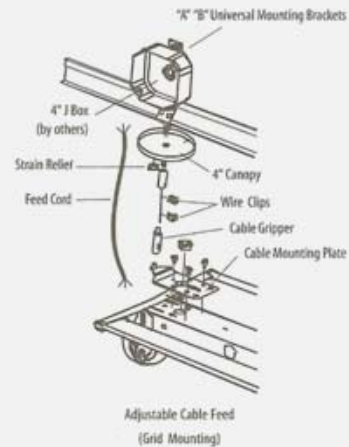
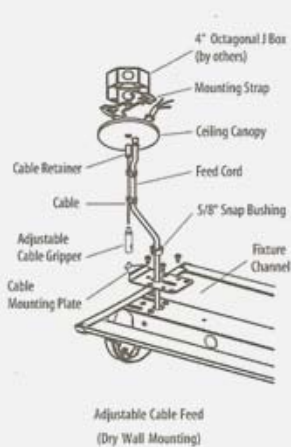
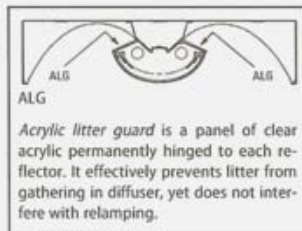

PSG9

[www.lithonia.com](http://www.lithonia.com)

LITHONIA LIGHTING



## FEATURES & SPECIFICATIONS

### INTENDED USE

For general area lighting or task-specific illumination in both new construction and remodeling applications. Especially suited for conference rooms, reception areas, health care institutions, educational facilities and offices.

### CONSTRUCTION

Rugged universal 4' steel channel provides platform for reflector/diffuser module. A tandem unit is an 8' channel with two 4' reflector/diffuser modules. Joiners and finished ends are injection molded from tough ABS/PC blend with integral Avante white color.

All diffusers snap into place by pivoting on joiner/light trap for easy lamp access. Injection molded joiners at each end allow fixtures to be field joined or completed as individual units with snap-on finished ends.

### OPTICAL SYSTEM

Down light, solid (DLS) reflector finished in high reflectance matte-white polyester powder paint provides uniform light distribution. DLS is available with aluminum stepped reflector (ASR).

Up light, round hole perforated band (ULR) reflector finished in high reflectance matte white polyester powder paint has uniform light distribution with up light accent provided by 1-3/8" wide perforated band just above lamps.

All diffusers shield lamps from direct view.

Metal diffuser staggered round holes (MDR) 52% open perforated metal with .075" diameter holes backed with white acrylic diffuser.

Metal diffuser aligned mini slots (MDM) 46% open perforated metal backed with white acrylic diffuser.

Straight blade louver (SBL) sides of perforated metal with staggered round holes and solid blade louvered center. Sides and louver backed with white acrylic diffuser.

### ELECTRICAL SYSTEM

All ballasts supplied are class P, thermally protected, resetting, HPF, non-PCB, UL Listed, CSA Certified. Energy saving and electronic ballasts are sound rated A. Standard combinations conform to UL 935. All T5 and T5HO ballasts are program start.

### INSTALLATION

AVSM can be directly mounted to most ceiling surfaces. Clips provided with fixture for surface mounting on tee bar in grid tiled ceilings. With mounting accessories fixtures can be close to ceiling stem mounted or cable mounted up to 144". Refer to the accessories tab for information on mounting configurations and limitations. Consult National Electrical Codes specifications for through wiring limitations.

### LISTING

UL Listed to US and Canadian safety standards (see Options). NYC approved (see Options).

Catalog Number	
Notes	Type

Surface/Suspended Mount Lighting

# AVSM 1' x 4'

*Avante*  
Recessed Direct/Indirect Lighting

Linear Fluorescent  
T5 or T5HO  
1 or 2 lamp

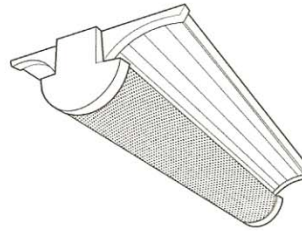

### Specifications

Length: 48" (1219)  
Width: 12" (305)  
Diffuser Width: 5-1/2" (140)  
Depth: 4-3/8" (111)

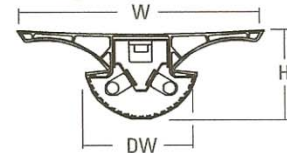

All dimensions are inches (millimeters).

Specifications are subject to change without notice.

Avante is covered by one or more of the following patents:  
5,988,829; 399,586; 411,641; 413,402; 2,212,513; 87,513.

## ORDERING INFORMATION

Example: AVSM 2 54T5HO MDR DLS MVOLT GEB10PS

Series	Number of lamps	Lamp type	Diffuser	Voltage	Options
AVSM 1' wide	1, 2 Not included.	28T5 28W T5 (46")	MDR Metal diffuser, round holes	347 MVOLT <sup>2</sup> Others available.	GEB10PS Electronic ballast, ≤10% THD, Program Start (standard)
TAVSM 1' wide, 8' long unit with 4' lamps end to end		54T5HO 54W T5HO (46")	SBL Straight blade louver, round holes		ALG Acrylic litter guard <sup>3</sup>
			MDM Metal diffuser, mini slots Others available.		EL14 Emergency battery pack (nominal 1200 lumens), see Life Safety section <sup>4</sup>
					GLR Internal fast-blow fuse <sup>5</sup>
					LP_ Lamped. Specify lamp type and color
					CSA Listed and labeled to comply with Canadian Standards
					NYC New York City approved
					Reflector option
					ASR Aluminum stepped reflector (only available with DLS)

Notes:

- For suspended mounting only.
- MVOLT (120 - 277 volt).
- Refer to options and accessories tab for more detailed information.
- Not available in Canada.
- Not available with MVOLT.

### Accessories

- Order as separate catalog number.<sup>3</sup>
- AVACF\_ Avante adjustable cable feed accessory kit.<sup>3</sup>
- AVAC\_ Avante adjustable cable non-feed accessory kit.<sup>3</sup>
- SCY\_ Stem-mount canopy accessory kit.<sup>2</sup>

### Light distribution

- DLS Down light, solid
- ULR Up light, round holes<sup>1</sup>

Fluorescent

Sheet #: AVSM 1x4 T5

ARCH-140

# AVSM 1x4 Linear Fluorescent T5

AVSM 1 54T5HO MDR DLS, (1) 54W T5HO lamp, 4400 lumens per lamp, s/m 1.2 (along) 1.4 (across), test no. LTL 9591

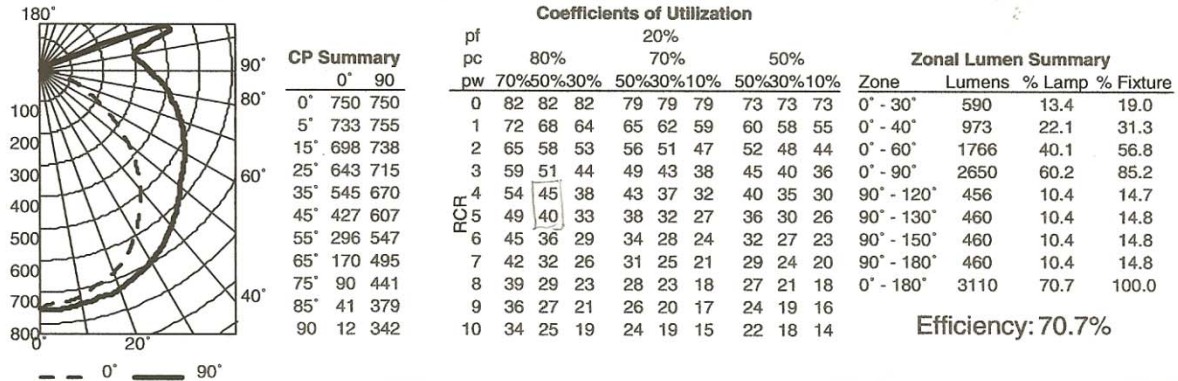

AVSM 2 54T5HO SBL DLS ASR, (2) 54W T5HO lamps, 4400 lumens per lamps, s/m 1.2 (along) 1.6 (across), test no. LTL10819

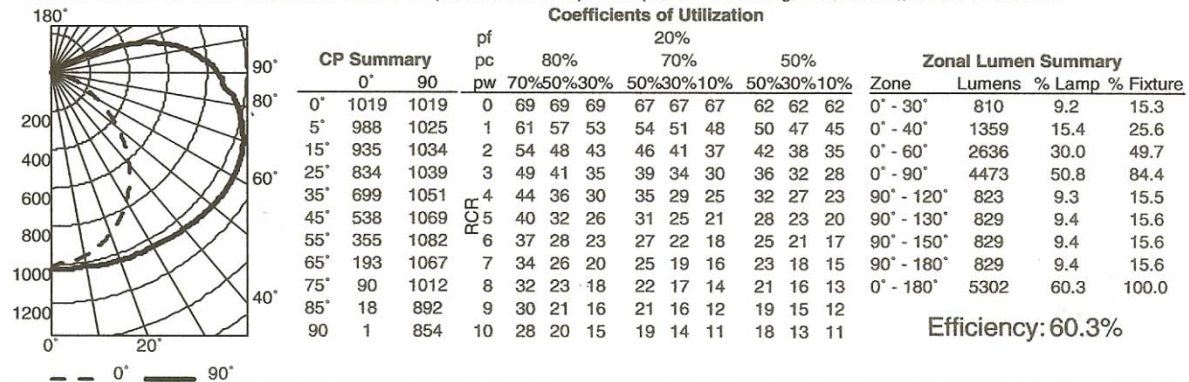

\*For additional photometric information, visit lithonia.com.

## MOUNTING DATA

Drawings are not to scale. For dimensional purposes only.

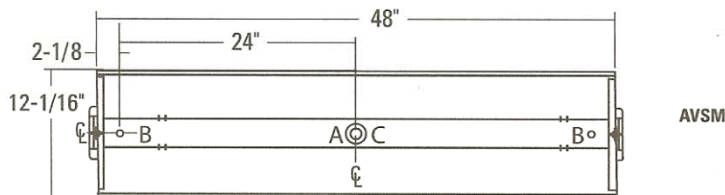

**KEY:** A = 5/8" Knockout  
B = 7/8" Knockout  
C = 2" Double Knockout

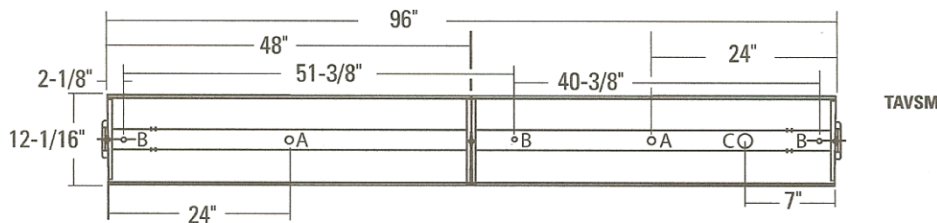

An AcuityBrands Company

Sheet #: AVSM 1X4 T5

©2007 Acuity Brands Lighting, Inc., Rev. 2/16/09

Lithonia Lighting  
Fluorescent  
One Lithonia Way, Conyers, GA 30012  
Phone: 800-858-7763 Fax: 770-929-8789  
www.lithonia.com



**AVSM 1 54T5HO MDR ULR - OUTDOOR PHOTOMETRIC REPORT**

CATALOG #: AVSM 1 54T5HO MDR ULR  
 LUMINAIRE: 1X4 AVANTE, SURFACE OR SUSPENDED MOUNT, 1 LAMP T5 HIGH OUTPUT 54 WATT, METAL DIFFUSER W/ ROUND PERFORATIONS BACKED W/ ACRYLIC OVERLAY, PERFD BAND WHITE UP LIGHT REFLECTOR.  
 LAMP CAT #: F54W/835  
 LAMP: ONE 54--WATT T5 LINEAR FLUORESCENT, RATED 4400 LUMENS (25 DEG. C AMBIENT).  
 LAMP OUTPUT: 1 LAMP(S), RATED LUMENS/LAMP: 4400  
 BALLAST: B254PUNV-D (1 LAMP MODE) MFR PUBL BF = 1.10  
 INPUT WATTAGE: 64  
 LUMINOUS OPENING: RECTANGLE (L: 3.90FT, W: 1.00FT)  
 EFFICIENCY: 70%  
 TER CATAGORY: SURFACE MOUNT, LINEAR  
 TER VALUE: 38  
 CIE CLASS: SEMI-DIRECT  
 MAX CD: 696.0 AT HORIZONTAL: 45°, VERTICAL: 2.5°  
 SPACING CRITERION @ 0 = 1.2  
 @ 90 = 1.38



Product Page

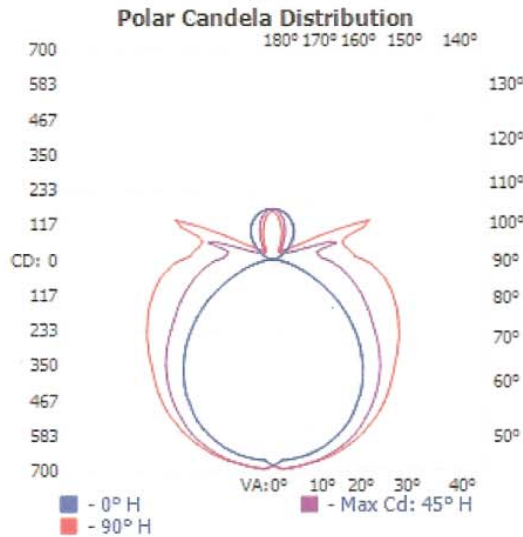

**LUMENS PER ZONE**

ZONE	LUMENS	% TOTAL	ZONE	LUMENS	% TOTAL
0-10	64.9	2.1%	90-100	162.1	5.3%
10-20	187.6	6.1%	100-110	156.5	5.1%
20-30	288.2	9.4%	110-120	103.3	3.4%
30-40	353.0	11.5%	120-130	43.0	1.4%
40-50	375.6	12.2%	130-140	39.0	1.3%
50-60	359.5	11.7%	140-150	42.4	1.4%
60-70	319.3	10.4%	150-160	46.5	1.5%

**ZONAL LUMEN SUMMARY**

ZONE	LUMENS	% LAMP	% LUMINAIRE
0-30	540.7	12.3%	17.6%
0-40	893.6	20.3%	29.1%
0-60	1,628.7	37%	53%
60-90	800.4	18.2%	26%
0-90	2,429.2	55.2%	79%
90-180	646.4	14.7%	21%
0-180	3,075.6	69.9%	100%

70-80 267.9 8.7% 160-170 38.5 1.3%  
 80-90 213.2 6.9% 170-180 15.1 0.5%

EFFICIENCY TOTAL: 69.9%

AVERAGE LUMINANCE (CD/M2)					
	0	22.5	45	67.5	90
0	1891	1891	1891	1891	1891
45	1577	1706	1944	2088	2158
55	1357	1588	1963	2276	2411
65	1038	1450	2188	2756	2965
75	725	1429	2901	3946	4319
85	443	2660	6650	9690	10767

COEFFICIENTS OF UTILIZATION - ZONAL CAVITY METHOD

EFFECTIVE FLOOR CAVITY REFLECTANCE: 20%

RCC %:	80				70				50			30			10			0
RW %:	70	50	30	0	70	50	30	0	50	30	20	50	30	20	50	30	20	0
RCR: 0	.80	.80	.80	.80	.76	.76	.76	.55	.70	.70	.70	.63	.63	.63	.58	.58	.58	.55
1	.71	.67	.63	.60	.67	.64	.60	.43	.58	.55	.53	.53	.51	.49	.48	.46	.45	.42
2	.64	.57	.52	.47	.60	.55	.50	.35	.50	.46	.42	.45	.42	.39	.41	.39	.36	.34
3	.58	.50	.44	.39	.55	.48	.42	.29	.43	.39	.35	.39	.36	.32	.36	.33	.30	.28
4	.53	.44	.37	.32	.50	.42	.36	.25	.38	.33	.29	.35	.31	.27	.32	.28	.26	.23
5	.48	.39	.32	.28	.46	.37	.31	.21	.34	.29	.25	.31	.27	.24	.28	.25	.22	.20
6	.44	.35	.29	.24	.42	.33	.28	.19	.31	.26	.22	.28	.24	.21	.26	.22	.19	.17
7	.41	.32	.25	.21	.39	.30	.24	.16	.28	.23	.19	.26	.21	.18	.23	.20	.17	.15
8	.38	.29	.23	.19	.36	.28	.22	.15	.25	.21	.17	.23	.19	.16	.22	.18	.15	.14
9	.36	.26	.20	.17	.34	.25	.20	.13	.23	.19	.15	.22	.17	.14	.20	.16	.14	.12
10	.33	.24	.19	.15	.32	.23	.18	.12	.22	.17	.14	.20	.16	.13	.18	.15	.12	.11

Visual Photometric Tool 1.2.13 copyright 2009, Acuity Brands Lighting  
 Reported data calculated from manufacturer's data file, based on IESNA recommended methods.



BALLAST SELECTION SPEC.

Product Line Guide - Electronic Ballasts

Item Number	OSRAM SYLVANIA Description	Input Voltage (VAC)	Input Current (AMPS)	Lamp Type	Rated Lumens (lm)	No. of Lamps	Ballast Factor (BF)	System Lumens	Input Wattage (W)	System Efficacy (lm/W)
<b>QUICKTRONIC® PROFESSIONAL T5HO PROStart® PSN UNIVERSAL VOLTAGE SYSTEMS</b>										
<b>NORMAL BALLAST FACTOR<sup>3</sup></b>										
49111 (49110)*	QTP 2x39-24T5HO/UNV PSN NL	120-277	0.47/0.20	FP24T5HO	2000	2 1	1.00 1.00	4000 2000	55/54 29	73/74 70
49111 (49110)*	QTP 2x39-24T5HO/UNV PSN NL	120-277	0.76/0.32	FP39T5HO	3500	2 1	1.00 1.00	7000 3500	85/83 42	82/84 83
49131 (49130)*	QTP 2x54T5HO/UNV PSN NL	120-277	1.00/0.43	FP54T5HO	5000	2 1	1.00 1.00	10000 5000	121/118 61	83/85 82
49151 (49150)*	QTP 1x80T5HO/UNV PSN NL	120-277	0.74/0.32	FP80T5HO FT80T5DL	6000 7000	1 1	1.00 1.00	7000 6000	90 90	78 67
* (Item Number) = Item Number/NAED in parentheses are models with leads/wires. See Ballast Technology & Specification Guide for additional lamp types and full specifications.										
<b>QUICKTRONIC® PROFESSIONAL T5 PROStart® PSN UNIVERSAL VOLTAGE SYSTEMS</b>										
<b>NORMAL BALLAST FACTOR<sup>3</sup></b>										
49181 (49180)*	QTP 2x28T5/UNV PSN NL	120-277	0.55/0.23	FP28T5	2900	2 1	1.00 1.00	5800 2900	65/63 32	89/92 90
PROStart® QTP PSN models above also operate these lamps: FP14, FP21 & FP35 * (Item Number) = Item Number/NAED in parentheses are models with leads/wires.										
<b>QUICKTRONIC® PROFESSIONAL T5HO PROStart® UNIVERSAL VOLTAGE HIGH AMBIENT TEMP. SYSTEMS</b>										
<b>FIXED OUTPUT<sup>3</sup></b>										
49136 (49135)*	QTP 2x54T5HO/UNV PSN HT NL	120-277	1.00/0.43	FP54T5HO	5000	2 1	1.00 1.00	10000 5000	121/118 61	83/85 82
<b>SWITCHABLE MODEL<sup>3</sup></b>										
49161 (49160)*	QTP 4x54T5HO/UNV PSN HTW NL	120-277	2.00/0.85	FP54T5HO	5000	4 3 2 1	1.00 1.00 1.00 1.00	20000 15000 10000 5000	241/236 182/178 121/118 61	83/85 83/85 83/85 82
PROStart® QTP PSN models above also operate these lamps: FT55DL, FPC55, L58 * (Item Number) = Item Number/NAED in parentheses are models with leads/wires.										
<b>QUICKTRONIC® PROFESSIONAL T5HO PROStart® 347- 480V HIGH AMBIENT TEMP. SYSTEMS</b>										
<b>NORMAL BALLAST FACTOR<sup>3</sup></b>										
49146 (49145)*	QTP 2x54T5HO/347-480 PSN HT NL	347-480	0.35/0.25	FP54T5HO	5000	2 1	1.00 1.00	10000 5000	121/120 61	83 82
PROStart® QTP PSN models above also operate these lamps: FT55DL, FPC55, L58 * (Item Number) = Item Number/NAED in parentheses are models with leads/wires.										
<b>QUICKTRONIC® HIGH EFFICIENCY INSTANT START DL40 UNIVERSAL VOLTAGE SYSTEMS<sup>4</sup></b>										
49428	QHE 1x40DL/UNV ISN-SC	120-277	0.30/0.13 0.27/0.12	FT40T5 FT40DL/28W/SS/IS	3150 2800	1 1	0.90 1.07	2835 2995	35 32	81 94
49429	QHE 2x40DL/UNV ISN-SC	120-277	0.56/0.26 0.54/0.24	FT40T5 FT40DL/28W/SS/IS	3150 2800	2 2	0.90 1.07	5670 5990	68/67 64/63	83/84 94/95
49430	QHE 3x40DL/UNV ISN-SC	120-277	0.84/0.36 0.79/0.35	FT40T5 FT40DL/28W/SS/IS	3150 2800	3 3	0.90 1.07	8505 8990	100/99 95/94	85/86 95/96
<sup>4</sup> Ballast factor based upon 225mA nominal lamp current for FT40DL lamp and 190mA nominal lamp current for FT40DL/28W/SS/IS lamp.										
<b>QUICKTRONIC® PROFESSIONAL PROStart® DL40</b>										
<b>NORMAL BALLAST FACTOR</b>										
50320	QTP 1x40TT5/120 PSN-F Formerly: M1-PN-TT5/40-F-120	120	0.32	FT40T5	3150	1	0.88	2770	38	73
50330	QTP 1x40TT5/277 PSN-F Formerly: M1-PN-TT5/40-F-277	277	0.13	FT40T5	3150	1	0.88	2770	37	75
50340	QTP 2x40TT5/120 PSN-F Formerly: M2-PN-TT5/40-F-120	120	0.63	FT40T5	3150	2	0.88	5545	76	73
50350	QTP 2x40TT5/277 PSN-F Formerly: M2-PN-TT5/40-F-277	277	0.27	FT40T5	3150	2	0.88	5545	73	76
50360	QTP 3x40TT5/120 PSN-B Formerly: M3-PN-TT5/40-B-120	120	0.92	FT40T5	3150	3	0.88	8315	110	76
50370	QTP 3x40TT5/277 PSN-B Formerly: M3-PN-TT5/40-B-277	277	0.39	FT40T5	3150	3	0.88	8315	108	77

<sup>3</sup>: Rated lamp lumens and performance data based on PENTRON® HO lamps. Rated lumens at 35°C lamp ambient temperature

# APPENDIX C: GRAVITY SYSTEMS

## SLAB THICKNESS CHECK

SLAB THICKNESS @ 10 <sup>TH</sup> & 11 <sup>TH</sup> FLRS.	RESIDENCE INN	KMR	1/2																				
<p>→ CHECK IF ORIG. DES. OK FOR NEW CRITICAL LOADS</p> <p>ASSUMPTIONS: <math>f'_c = 4000 \text{ psi}</math>  <math>f_y = 60000 \text{ psi}</math></p> <p>COLS. 14" x 24" (TYP.)</p> <p>8" SLAB → 100 PSF</p> <p>DDM</p> <p>LOADS: (@ CRITICAL LOCATION)</p> <p style="text-align: center;"><u>DEAD</u></p> <table style="margin-left: auto; margin-right: auto;"> <tr> <td>SDL</td> <td>15 PSF</td> <td></td> <td></td> </tr> <tr> <td>GREEN ROOF</td> <td>45 PSF</td> <td></td> <td></td> </tr> <tr> <td>SLAB SW</td> <td>100 PSF</td> <td>(8")</td> <td>(125 PSF - 10")</td> </tr> <tr> <td></td> <td>160 PSF</td> <td></td> <td></td> </tr> <tr> <td></td> <td>195</td> <td></td> <td></td> </tr> </table> <p style="text-align: center;"><u>LIVE</u></p> <p>ROOFS W/ GARDENS 100 PSF (NO LLR FOR SIZING SLAB ITSELF)</p> <p>LC: <math>1.2D + 1.6L_r</math></p> <p style="text-align: center;"> <math>= 1.2(160 \text{ PSF}) + 1.6(100 \text{ PSF}) = \underline{352 \text{ PSF}} = \underline{0.352 \text{ KSF}}</math>              (HOTEL FLRS = 0.195 KSF)         </p> <p>→ <u>CHECK PUNCHING SHEAR:</u></p> <p style="text-align: right; font-size: small;">PREV. CALC. 10/6/08 FOR 8" SLAB</p> <p style="text-align: center;"> <math>V_u = 0.352 \text{ KSF} ((21.5' \times 18.33') - (\frac{20.75}{12} \times \frac{30.75}{12})) = 137 \text{ K} &gt; \phi V_c = 109 \text{ K}</math>  <math>\therefore \underline{NG}</math> </p> <p>→ TRY 10" SLAB</p> <div style="display: flex; justify-content: space-around; align-items: flex-start;"> <div style="text-align: center;"> <p>21.5'</p> <p>18.33'</p> <p>14x24 COL.</p> <p>22.75'</p> <p>14.75'</p> <p><math>\frac{d}{2} = 4.375'</math></p> </div> <div style="text-align: center;"> <p><math>d_{\text{long}} = 10'' - 0.75'' - \frac{1}{2}(0.5'')</math>  <math>= 9''</math></p> <p><math>d_{\text{short}} = 10'' - 0.75'' - 0.5'' - \frac{1}{2}(0.5'')</math>  <math>= 8.5''</math></p> <p><math>d_{\text{avg}} = \frac{1}{2}(9'' + 8.5'') = 8.75''</math></p> <p><math>\beta = \frac{24}{14} = 1.71</math></p> <p><math>b_o = 2(14'') + 2(24'') = 76''</math></p> </div> </div>				SDL	15 PSF			GREEN ROOF	45 PSF			SLAB SW	100 PSF	(8")	(125 PSF - 10")		160 PSF				195		
SDL	15 PSF																						
GREEN ROOF	45 PSF																						
SLAB SW	100 PSF	(8")	(125 PSF - 10")																				
	160 PSF																						
	195																						

SLAB THICKNESS @ 10 <sup>TH</sup> & 11 <sup>TH</sup> FLRS.	RESIDENCE INN	KMR	2/ 2
<p style="text-align: center;">w   SW OF 10" SLAB</p> <p>w   10" SLAB: <math>1.2(185 \text{ PSF}) + 1.6(100 \text{ PSF}) = 0.382 \text{ KSF}</math></p> <p><math>V_u = 0.382 \text{ KSF} \left( (21.5' \times 18.33') - \left( \frac{22.75}{12} \times \frac{32.75}{12} \right) \right) = \underline{149 \text{ K}}</math></p> <p><math>\phi V_c = \begin{cases} 0.75 \left( 2 + \frac{4}{2.14} \right) \sqrt{4000} (88") (8.75") / 1000 = \underline{141 \text{ K}} \text{ governs} \\ \text{smallest of } \left\{ \begin{aligned} &amp;0.75 \left( \frac{40(8.75)}{88} + 2 \right) \sqrt{4000} (88) (8.75) / 1000 = 218 \text{ K} \\ &amp;0.75(4) \sqrt{4000} (88) (8.75) / 1000 = 146 \text{ K} \end{aligned} \right.</math></p> <p><math>V_u = 149 \text{ K} &gt; \phi V_c = 141 \text{ K} \therefore \underline{\text{NG}}</math> [10" SLAB, 4000 psi CONC.]  <math>\rightarrow</math> USE <u>14" x 30" COLS.</u> <math>\rightarrow V_u = 136 \text{ K} &lt; \phi V_c = 141 \text{ K} \therefore \underline{\text{OK}}</math> 14" x 30" COLS.</p> <p><math>\rightarrow</math> CHECK WIDE-BM. ACTION SHEAR:</p> <p><math>V_u = 0.382 \text{ KSF} \left( \frac{21.5'}{2} - \frac{14"}{12 \cdot 2} - \frac{8.75"}{12} \right) = 3.60 \text{ K} / 12" \text{ OF SLAB}</math></p> <p><math>\phi V_c = 0.75(2) \sqrt{4000} (12") (8.75") / 1000 = 9.96 \text{ K} &gt; V_u = 3.60 \text{ K}</math>  <math>\therefore \underline{\underline{\text{OK}}}</math> (12" strip)</p> <p><math>\rightarrow</math> USE 5000 psi CONC. THROUGHOUT, THEN DON'T NEED SHEAR REINF FOR 14" x 24" COLS</p> <p><math>\phi V_c = 158 \text{ K} &gt; V_u = 149 \text{ K} \therefore \underline{\underline{\text{OK}}}</math></p>			

COLUMN UNBALANCED MOMENTS CALCULATIONS

COLUMN UNBALANCED MOM.	RESIDENCE INN	KMR 1/5
------------------------	---------------	---------

**COL. F-3 (INT. COL.)**

LOADS:

2<sup>ND</sup> → 9<sup>TH</sup> FLRS :  $w_D = 125$  PSF  
 $w_L = 40$  PSF

10<sup>TH</sup> → 11<sup>TH</sup> FLRS :  $w_D = 150$  PSF  
 $w_L = 65$  PSF

ROOF : 11<sup>TH</sup> FLR COLS. BELOW NOT CRITICAL ANYWAY

[ACI 13.6.9.2] :

$$M_u = 0.07 \left[ (q_{Du} + 0.5q_{Lu}) l_2 l_n^2 - q_{Du}' l_2' (l_n')^2 \right]$$

1<sup>ST</sup> → 8<sup>TH</sup> FLRS :  $w_{Du} = 1.2(125) = 150$   
 (≠ 11<sup>TH</sup> FLR)  $w_{Lu} = 1.6(40) = 64$   
 • LONG DIR.

$$M_u = 0.07 \left[ (1.2(125) + 0.5(1.6(40))) (16') (10.17')^2 - (1.2(125)) (16') (10.17')^2 \right]$$

$$= 3707 \text{ lb}\cdot\text{ft} = \underline{3.71}^k$$

• SHORT DIR.

$$M_u = 0.07 \left[ (150 + 0.5(64)) (21.5') (9.75')^2 - (150) (21.5') (3.75')^2 \right]$$

$$= 22,864 \text{ lb}\cdot\text{ft} = \underline{22.9}^k$$
  

9<sup>TH</sup> → 10<sup>TH</sup> FLRS :  $w_{Du} = 1.2(150) = 180$   
 $w_{Lu} = 1.6(65) = 104$

• LONG DIR.

$$M_u = 0.07 \left[ (180 + 0.5(104)) (16') (10.17')^2 - (180) (16') (10.17')^2 \right]$$

$$= 6,024 \text{ lb}\cdot\text{ft} = \underline{6.02}^k$$

COLUMN UNBALANCED MOM.	RESIDENCE INN	KMR	2/5
<p>• SHORT DIR.</p> $M_u = 0.07 \left[ (180 + 0.5(104))(21.5)(9.75)^2 - (180)(21.5)(3.75)^2 \right]$ $= 29,382 \text{ lb}\cdot\text{ft} = \underline{29.4^k}$			

**COL. G-6** (INT. & EXT. COL. - SEE SKETCHES BELOW)

1<sup>ST</sup> → 8<sup>TH</sup> FLRS: (INT. COL.)

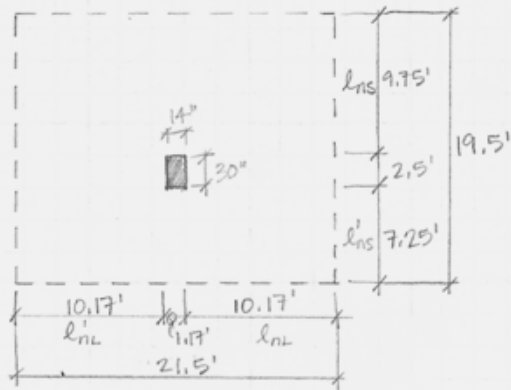

$W_D = 125 \text{ PSF}$   
 $W_{Du} = 1.2(125) = 150$

$W_L = 40 \text{ PSF}$   
 $W_{Lu} = 1.6(40) = 64$

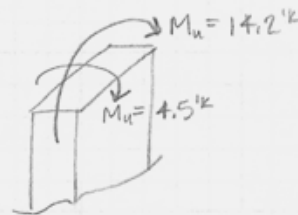

LONG DIR.

$$M_u = 0.07 \left[ (150 + 0.5(64))(19.5)(10.17)^2 - (150(19.5)(10.17)^2) \right]$$

$$= 4,518 \text{ lb}\cdot\text{ft} = \underline{4.5 \text{ k}}$$

[9<sup>TH</sup> FLR. COLS: 11.3 k]  
 (W<sub>Du</sub> = 234 ; W<sub>Lu</sub> = 160)

SHORT DIR.

$$M_u = 0.07 \left[ (150 + 0.5(64))(21.5)(9.75)^2 - (150(21.5)(7.25)^2) \right]$$

$$= 14,173 \text{ lb}\cdot\text{ft} = \underline{14.2 \text{ k}}$$

[9<sup>TH</sup> FLR. COLS: 26.4 k]

CRITICAL (MORE LOAD)  
 10<sup>TH</sup> → 11<sup>TH</sup> FLRS:

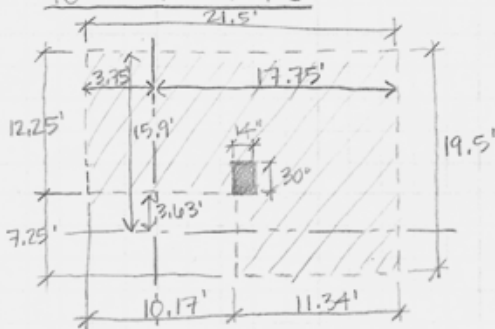

@ 10<sup>TH</sup> FLR (CRITICAL):

$W_D = 195 \text{ PSF}$   
 $W_{Du} = 1.2(195) = 234$

$W_L = 100 \text{ PSF}$   
 $W_{Lu} = 1.6(100) = 160$

\* CONSERVATIVELY ASSUMING EDGE COL. IN BOTH DIRECS.

LONG DIR.

$$M_u = \frac{1}{3} M_o = 0.3 \left[ \frac{1}{8} (234 + 160)(15.9') \left( 21.5 - \frac{14}{2} \right)^2 \right] = 97,127 \text{ lb}\cdot\text{ft}$$

$$= \underline{97.1 \text{ k}}$$

avg. to acct. for "cutout"

SHORT DIR.

$$M_u = \frac{1}{3} \left[ \frac{(234 + 160)(17.75')(19.5 - \frac{30}{2})^2}{8} \right] = 84,213 \text{ lb}\cdot\text{ft} = \underline{84.2 \text{ k}}$$



**COL. N-6** (INT. & EXT. COL. - SEE SKETCHES BELOW)

1<sup>ST</sup> → 8<sup>TH</sup> FLRS : (INT. COL.)  
(9<sup>TH</sup> SEP.)

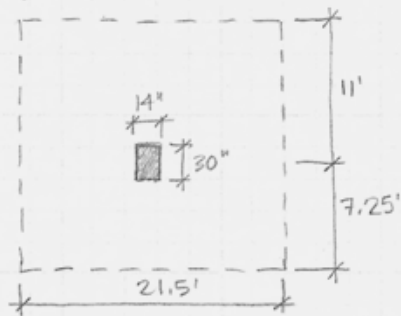

$$\left. \begin{aligned} W_D &= 125 \text{ PSF} \\ W_{DU} &= 1.2(125) = 150 \end{aligned} \right\} 2^{\text{ND}} \rightarrow 8^{\text{TH}}$$

$$\left. \begin{aligned} W_L &= 40 \text{ PSF} \\ W_{LU} &= 1.6(40) = 64 \end{aligned} \right\}$$

$$\left. \begin{aligned} W_{DU} &= 234 \\ W_{LU} &= 160 \end{aligned} \right\} 9^{\text{TH}}$$

LONG DIR.

$$M_u = 0.07 \left[ (150 + 0.5(64))(18.25)(10.17)^2 - (150)(18.25)(10.17)^2 \right]$$

$$= 4228 \text{ lb}\cdot\text{ft} = \underline{4.23^{\text{k}}} \quad [9^{\text{TH}} \text{ FLR} : \underline{10.6^{\text{k}}}]$$

SHORT DIR.

$$M_u = 0.07 \left[ (150 + 0.5(64))(21.5)(11 - 15/12)^2 - (150)(21.5)(7.25 - 15/12)^2 \right]$$

$$= 17,912 \text{ lb}\cdot\text{ft} = \underline{17.9^{\text{k}}} \quad [9^{\text{TH}} \text{ FLR} : \underline{32.2^{\text{k}}}]$$

10<sup>TH</sup> FLR : (EXT. COL.)

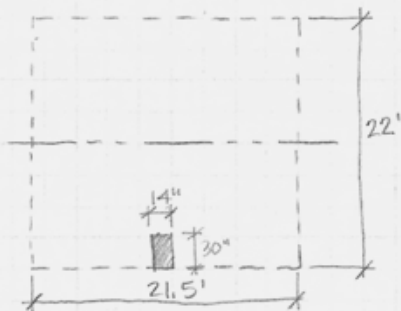

$$\left. \begin{aligned} W_D &= 150 \text{ PSF} \\ W_{DU} &= 1.2(150) = 180 \end{aligned} \right\}$$

$$\left. \begin{aligned} W_L &= 100 \\ W_{LU} &= 1.6(100) = 160 \end{aligned} \right\}$$

LONG DIR.

$$M_u = \frac{1}{3} \left[ \frac{(180 + 160)(21.5)(22 - 30/12)^2}{8} \right] = \underline{116^{\text{k}}} \quad [106^{\text{k}} : 11^{\text{TH}} \text{ FLR}]$$

SHORT DIR.

$$M_u = \frac{1}{3} \left[ \frac{(180 + 160)(22)(21.5 - 14/12)^2}{8} \right] = \underline{129^{\text{k}}} \quad [118^{\text{k}} : 11^{\text{TH}} \text{ FLR}]$$

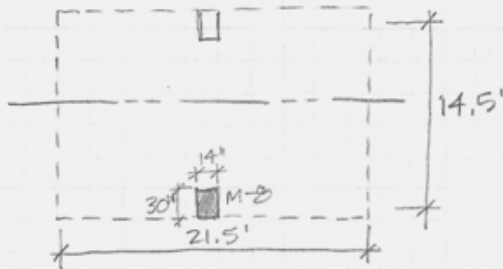
**COL. M-8** (EXT. COL.)

$$\left. \begin{aligned} W_D &= 125 \\ W_{DU} &= 1.2(125) = 150 \\ W_L &= 40 \\ W_{LU} &= 1.6(40) = 64 \end{aligned} \right\} \text{1ST} \rightarrow \text{8TH FLRS}$$

$$\left. \begin{aligned} W_{DU} &= 234 \\ W_{LU} &= 160 \end{aligned} \right\} \text{9TH FLR}$$

[NO COLS. HERE 10<sup>TH</sup> & 11<sup>TH</sup> FLRS]

LONG DIR.

$$M_u = \frac{1}{3} \left[ \frac{(150+64)(14.5)(21.5 - \frac{14}{12})^2}{8} \right] = \underline{\underline{53.5}} \text{ 'k} \quad [\text{1ST} \rightarrow \text{8TH}]$$

$$= \frac{1}{3} \left[ \frac{(234+160)(14.5)(21.5 - \frac{14}{12})^2}{8} \right] = \underline{\underline{98.5}} \text{ 'k} \quad [\text{9TH}]$$

SHORT DIR.

$$M_u = \frac{1}{3} \left[ \frac{(150+64)(21.5)(14.5 - \frac{30}{12})^2}{8} \right] = \underline{\underline{27.6}} \text{ 'k} \quad [\text{1ST} \rightarrow \text{8TH}]$$

$$= \frac{234+160}{150+64} (27.6) = \underline{\underline{50.8}} \text{ 'k} \quad [\text{9TH}]$$

PCA COLUMN – 11 STORY RE-DESIGN RESULTS

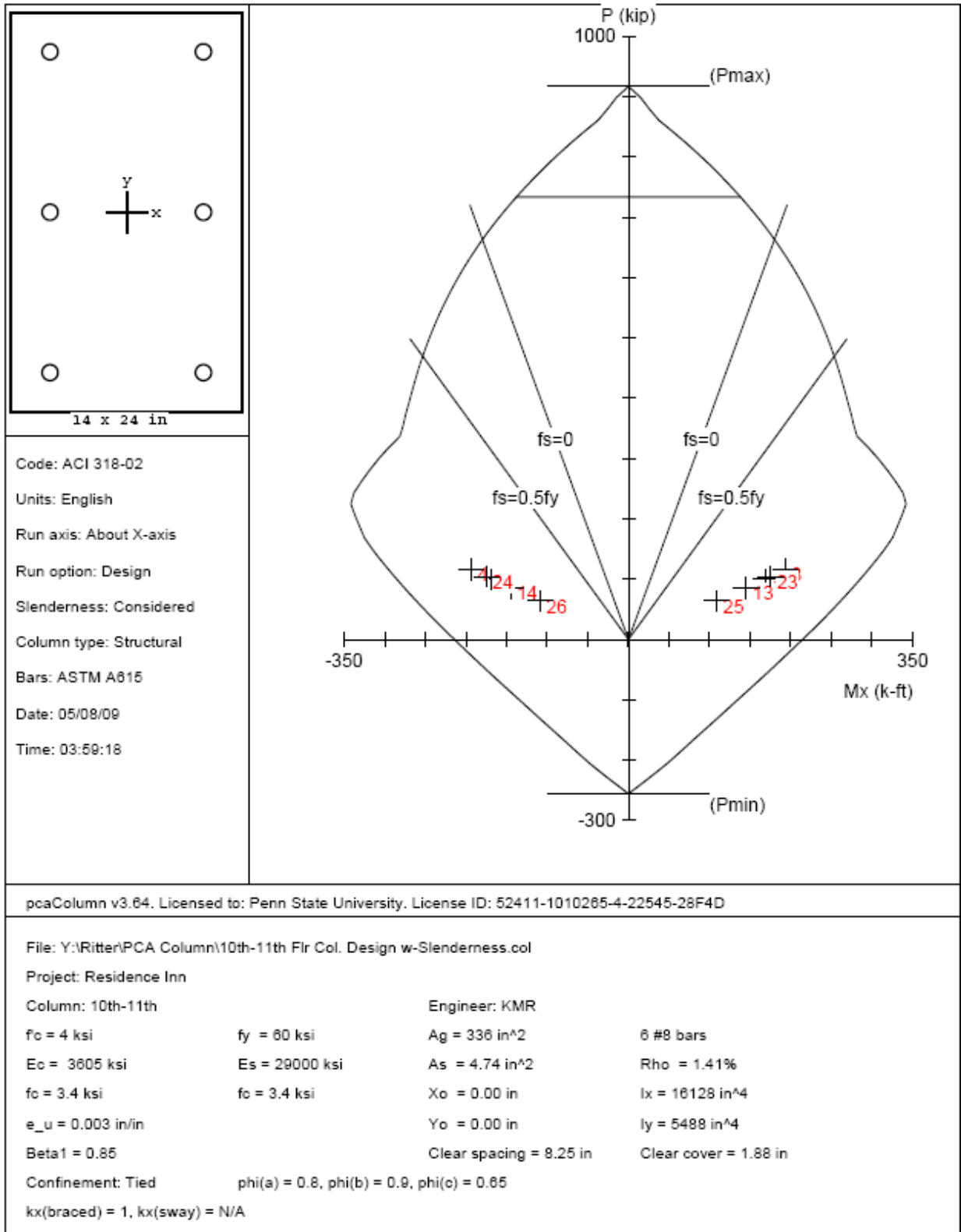

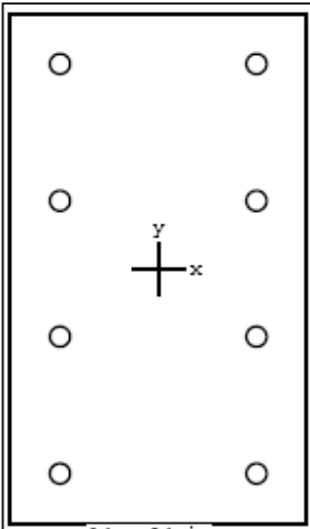

14 x 24 in

Code: ACI 318-02  
 Units: English  
 Run axis: About Y-axis  
 Run option: Design  
 Slenderness: Considered  
 Column type: Structural  
 Bars: ASTM A615  
 Date: 05/08/09  
 Time: 03:58:23

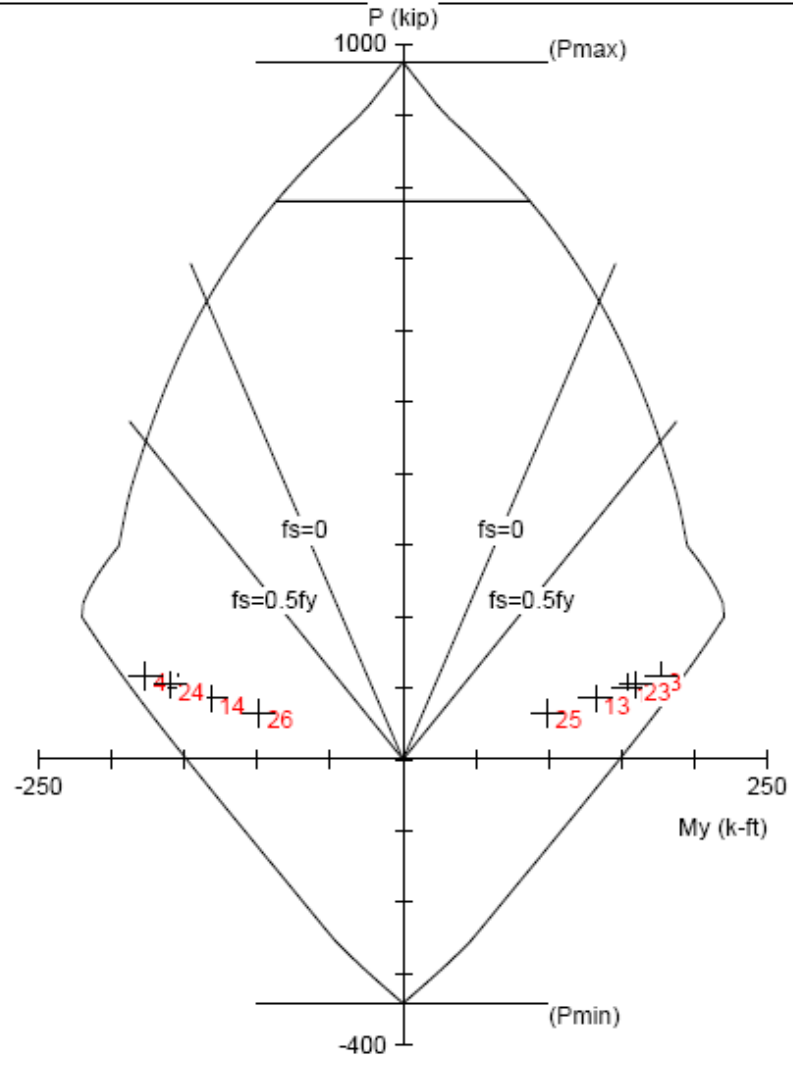

pcaColumn v3.64. Licensed to: Penn State University. License ID: 52411-1010265-4-22545-28F4D

File: Y:\Ritter\PCA Column\10th-11th Flr Col. Design w-Slenderness.col  
 Project: Residence Inn  
 Column: 10th-11th  
 Engineer: KMR

$f_c = 4$ ksi	$f_y = 60$ ksi	$A_g = 336$ in <sup>2</sup>	8 #8 bars
$E_c = 3605$ ksi	$E_s = 29000$ ksi	$A_s = 6.32$ in <sup>2</sup>	Rho = 1.88%
$f_c = 3.4$ ksi	$f_c = 3.4$ ksi	$X_o = 0.00$ in	$I_x = 16128$ in <sup>4</sup>
$e_u = 0.003$ in/in		$Y_o = 0.00$ in	$I_y = 5488$ in <sup>4</sup>
Beta1 = 0.85		Clear spacing = 5.42 in	Clear cover = 1.88 in
Confinement: Tied	$\phi(a) = 0.8, \phi(b) = 0.9, \phi(c) = 0.65$		
$k_y(\text{braced}) = 1, k_y(\text{sway}) = \text{N/A}$			

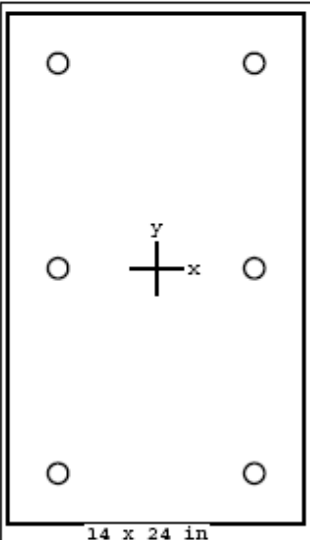

Code: ACI 318-02  
 Units: English  
 Run axis: About X-axis  
 Run option: Design  
 Slenderness: Considered  
 Column type: Structural  
 Bars: ASTM A615  
 Date: 05/08/09  
 Time: 04:20:08

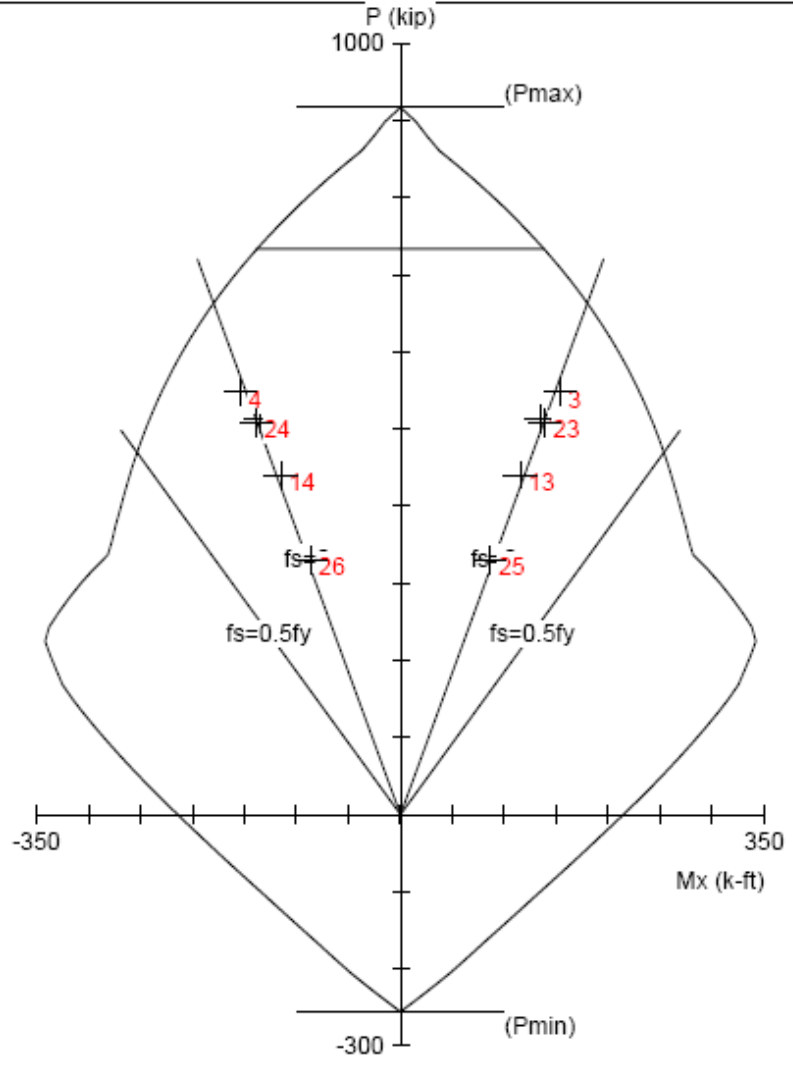

pcaColumn v3.64. Licensed to: Penn State University. License ID: 52411-1010265-4-22545-28F4D

File: Y:\Ritter\PCA Column\5th-9th Flr Col. Design Strong Axis w-Slenderness.col  
 Project: Residence Inn  
 Column: 5th-9th Flr  
 Engineer: KMR

$f_c = 4$ ksi	$f_y = 60$ ksi	$A_g = 336$ in <sup>2</sup>	6 #8 bars
$E_c = 3605$ ksi	$E_s = 29000$ ksi	$A_s = 4.74$ in <sup>2</sup>	$Rho = 1.41\%$
$f_c = 3.4$ ksi	$f_c = 3.4$ ksi	$X_o = 0.00$ in	$I_x = 16128$ in <sup>4</sup>
$e_u = 0.003$ in/in		$Y_o = 0.00$ in	$I_y = 5488$ in <sup>4</sup>
$Beta_1 = 0.85$		Clear spacing = 8.25 in	Clear cover = 1.88 in
Confinement: Tied	$\phi(a) = 0.8, \phi(b) = 0.9, \phi(c) = 0.65$		
$k_x(\text{braced}) = 1, k_x(\text{sway}) = N/A$			

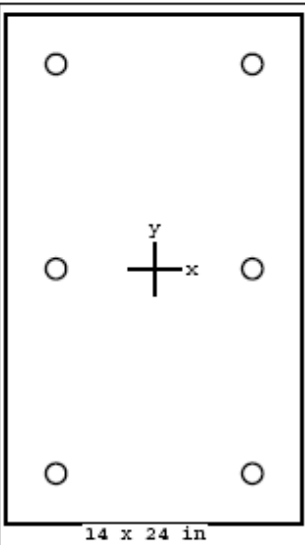

Code: ACI 318-02  
 Units: English  
 Run axis: About Y-axis  
 Run option: Design  
 Slenderness: Considered  
 Column type: Structural  
 Bars: ASTM A615  
 Date: 05/08/09  
 Time: 04:19:34

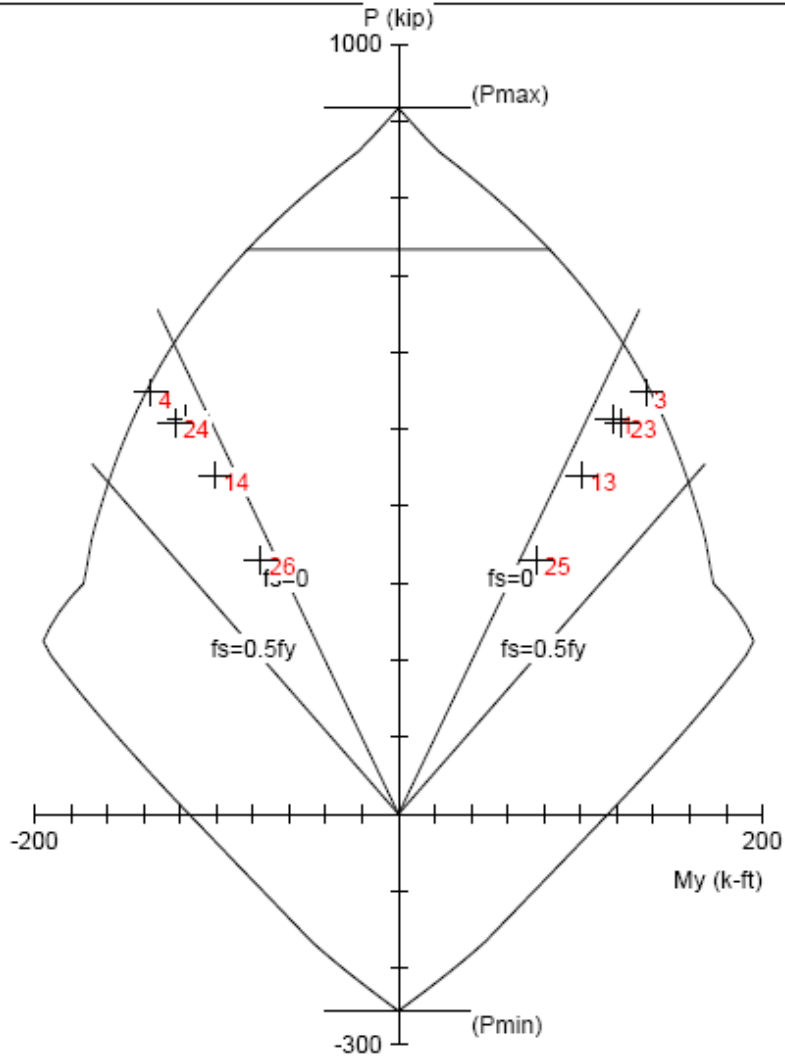

pcaColumn v3.64. Licensed to: Penn State University. License ID: 52411-1010265-4-22545-28F4D

File: Y:\Ritter\PCA Column\5th-9th Flr Col. Design Strong Axis w-Slenderness.col  
 Project: Residence Inn  
 Column: 5th-9th Flr  
 Engineer: KMR

$f_c = 4$ ksi	$f_y = 60$ ksi	$A_g = 336$ in <sup>2</sup>	6 #8 bars
$E_c = 3605$ ksi	$E_s = 29000$ ksi	$A_s = 4.74$ in <sup>2</sup>	Rho = 1.41%
$f_c = 3.4$ ksi	$f_c = 3.4$ ksi	$X_o = 0.00$ in	$I_x = 16128$ in <sup>4</sup>
$e_u = 0.003$ in/in		$Y_o = 0.00$ in	$I_y = 5488$ in <sup>4</sup>
Beta1 = 0.85		Clear spacing = 8.25 in	Clear cover = 1.88 in
Confinement: Tied	$\phi(a) = 0.8, \phi(b) = 0.9, \phi(c) = 0.65$		
$k_y(\text{braced}) = 1, k_y(\text{sway}) = \text{N/A}$			

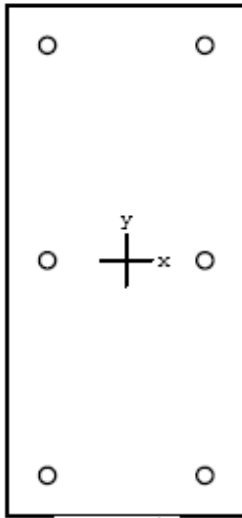

14 x 30 in

Code: ACI 318-02  
 Units: English  
 Run axis: About X-axis  
 Run option: Design  
 Slenderness: Considered  
 Column type: Structural  
 Bars: ASTM A615  
 Date: 05/08/09  
 Time: 04:08:05

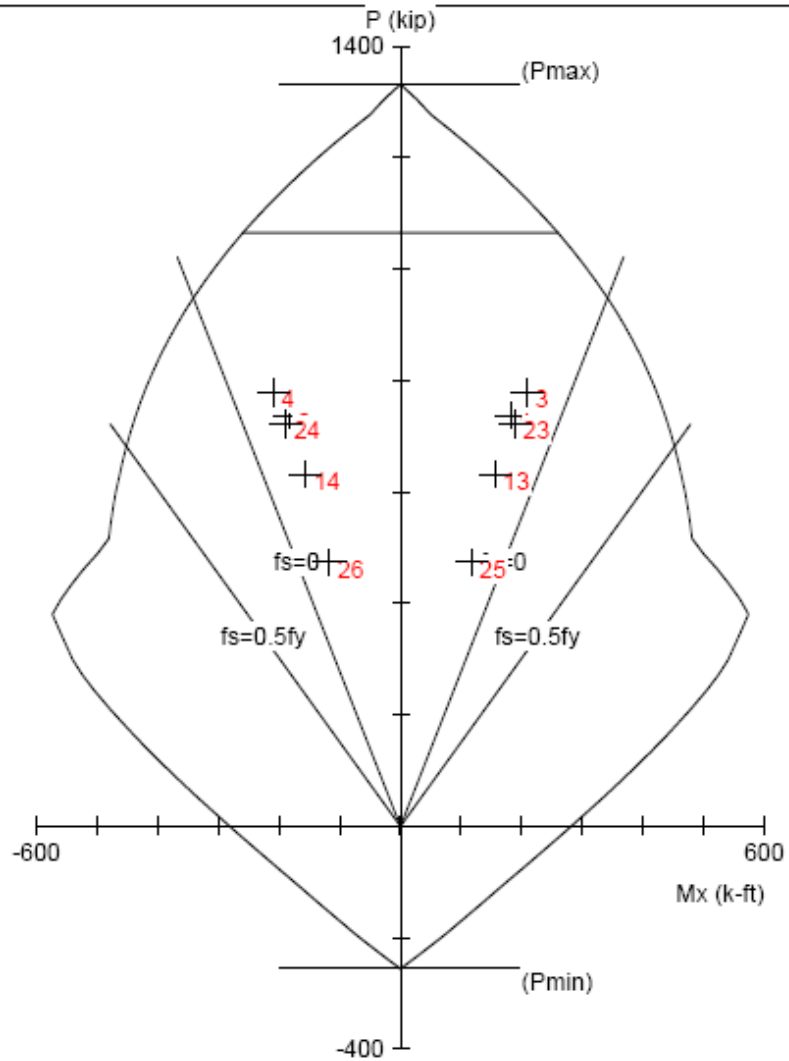

pcaColumn v3.64. Licensed to: Penn State University. License ID: 52411-1010265-4-22545-28F4D

File: Y:\Ritter\PCA Column\2nd-4th Flr Col. Design w-Slenderness.col

Project: Residence Inn

Column: 2nd-4th

Engineer: KMR

$f_c = 5$  ksi

$f_y = 60$  ksi

$A_g = 420$  in<sup>2</sup>

6 #8 bars

$E_c = 4031$  ksi

$E_s = 29000$  ksi

$A_s = 4.74$  in<sup>2</sup>

$\rho = 1.13\%$

$f_c = 4.25$  ksi

$f_c = 4.25$  ksi

$X_o = 0.00$  in

$I_x = 31500$  in<sup>4</sup>

$e_u = 0.003$  in/in

$Y_o = 0.00$  in

$I_y = 6880$  in<sup>4</sup>

Beta1 = 0.8

Clear spacing = 8.25 in

Clear cover = 1.88 in

Confinement: Tied

$\phi(a) = 0.8, \phi(b) = 0.9, \phi(c) = 0.65$

$k_x(\text{braced}) = 1, k_x(\text{sway}) = \text{N/A}$

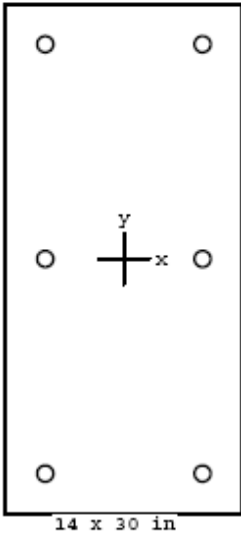

Code: ACI 318-02  
 Units: English  
 Run axis: About Y-axis  
 Run option: Design  
 Slenderness: Considered  
 Column type: Structural  
 Bars: ASTM A615  
 Date: 05/08/09  
 Time: 04:07:16

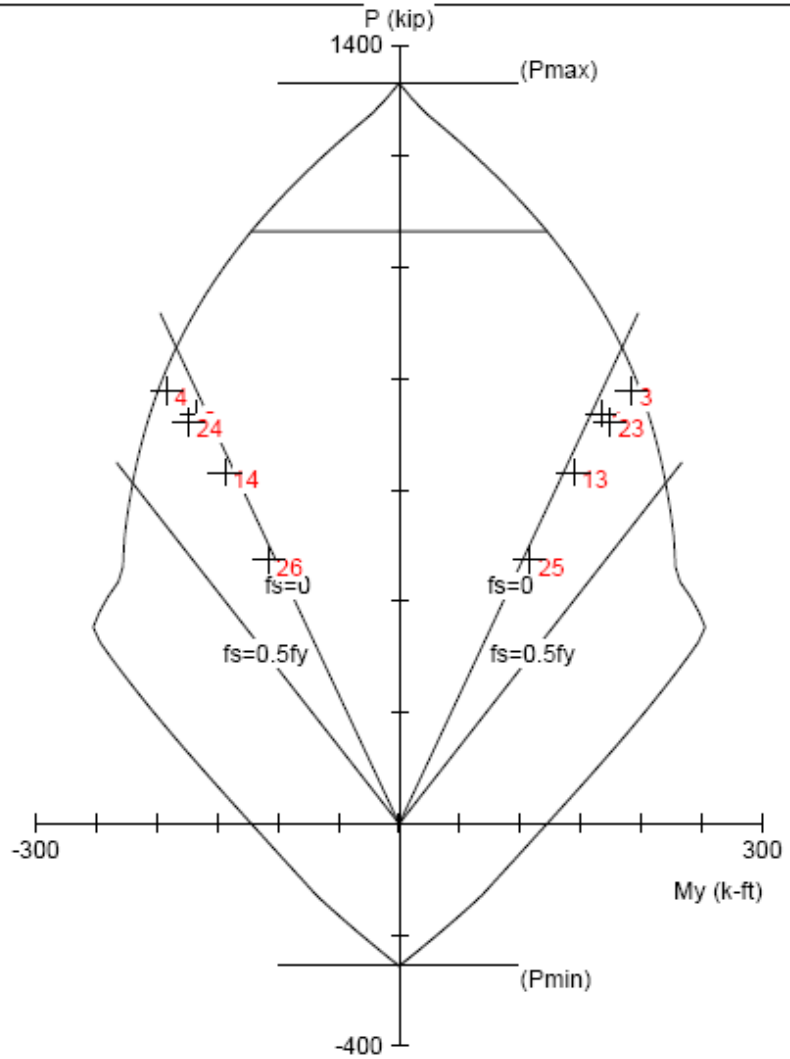

pcaColumn v3.64. Licensed to: Penn State University. License ID: 52411-1010285-4-22545-28F4D

File: Y:\Ritter\PCA Column\2nd-4th Flr Col. Design w-Slenderness.col

Project: Residence Inn

Column: 2nd-4th

Engineer: KMR

$f_c = 5$  ksi

$f_y = 60$  ksi

$A_g = 420$  in<sup>2</sup>

6 #8 bars

$E_c = 4031$  ksi

$E_s = 29000$  ksi

$A_s = 4.74$  in<sup>2</sup>

$Rho = 1.13\%$

$f_c = 4.25$  ksi

$f_c = 4.25$  ksi

$X_o = 0.00$  in

$I_x = 31500$  in<sup>4</sup>

$e_u = 0.003$  in/in

$Y_o = 0.00$  in

$I_y = 6880$  in<sup>4</sup>

Beta1 = 0.8

Clear spacing = 8.25 in

Clear cover = 1.88 in

Confinement: Tied

$\phi(a) = 0.8, \phi(b) = 0.9, \phi(c) = 0.65$

$k_y(\text{braced}) = 1, k_y(\text{sway}) = \text{N/A}$



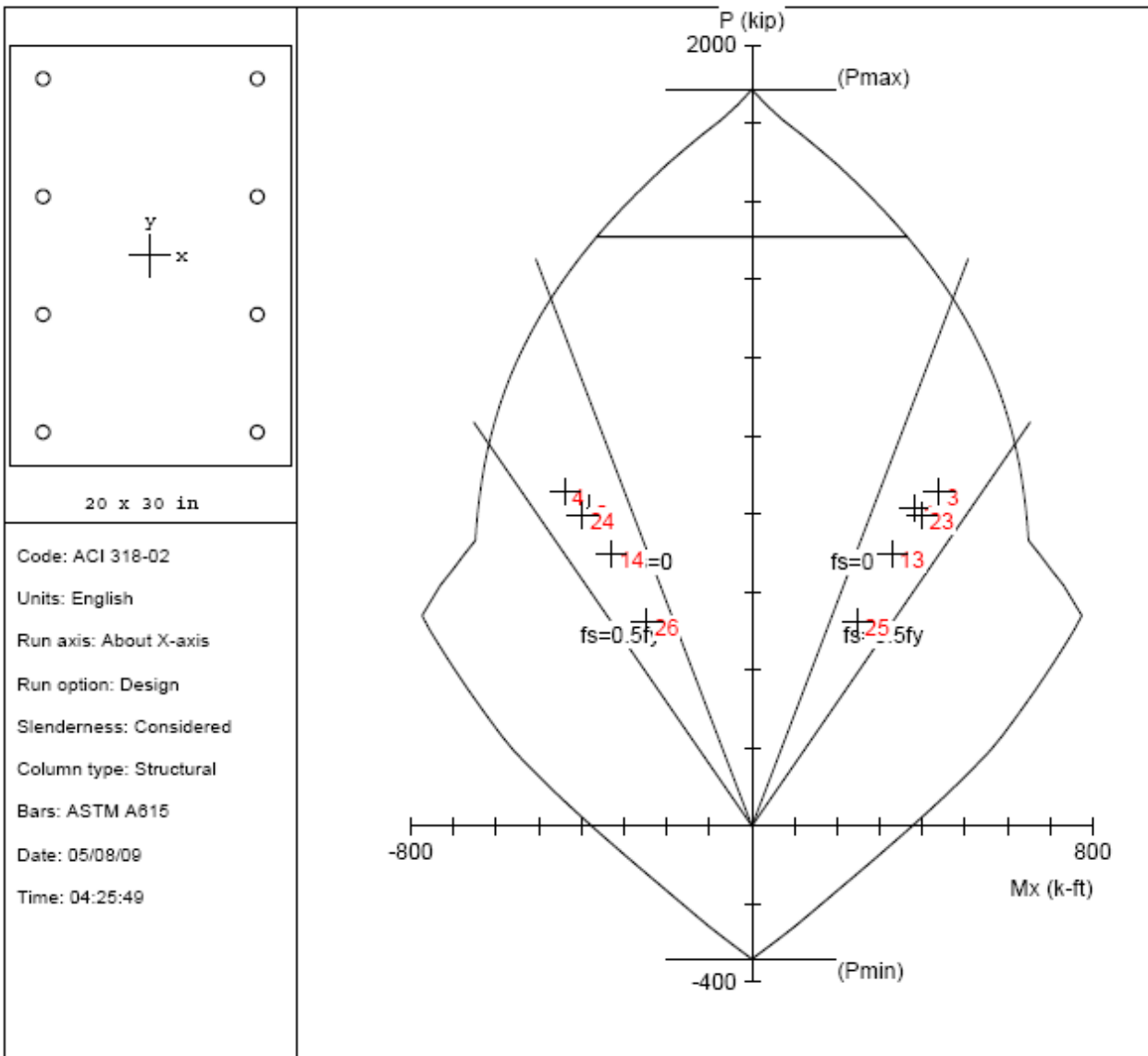

pcaColumn v3.64. Licensed to: Penn State University. License ID: 52411-1010265-4-22545-28F4D

File: Y:\Ritter\PCA Column\1st Flr Col. Design Axis.col

Project: Residence Inn

Column: 1st Flr.

Engineer: KMR

$f_c = 5$  ksi

$f_y = 60$  ksi

$A_g = 600$  in<sup>2</sup>

8 #8 bars

$E_c = 4031$  ksi

$E_s = 29000$  ksi

$A_s = 6.32$  in<sup>2</sup>

Rho = 1.05%

$f_c = 4.25$  ksi

$f_c = 4.25$  ksi

$X_o = 0.00$  in

$I_x = 45000$  in<sup>4</sup>

$e_u = 0.003$  in/in

$Y_o = 0.00$  in

$I_y = 20000$  in<sup>4</sup>

Beta1 = 0.8

Clear spacing = 7.42 in

Clear cover = 1.88 in

Confinement: Tied

$\phi(a) = 0.8, \phi(b) = 0.9, \phi(c) = 0.65$

$k_x(\text{braced}) = 1, k_x(\text{sway}) = \text{N/A}$

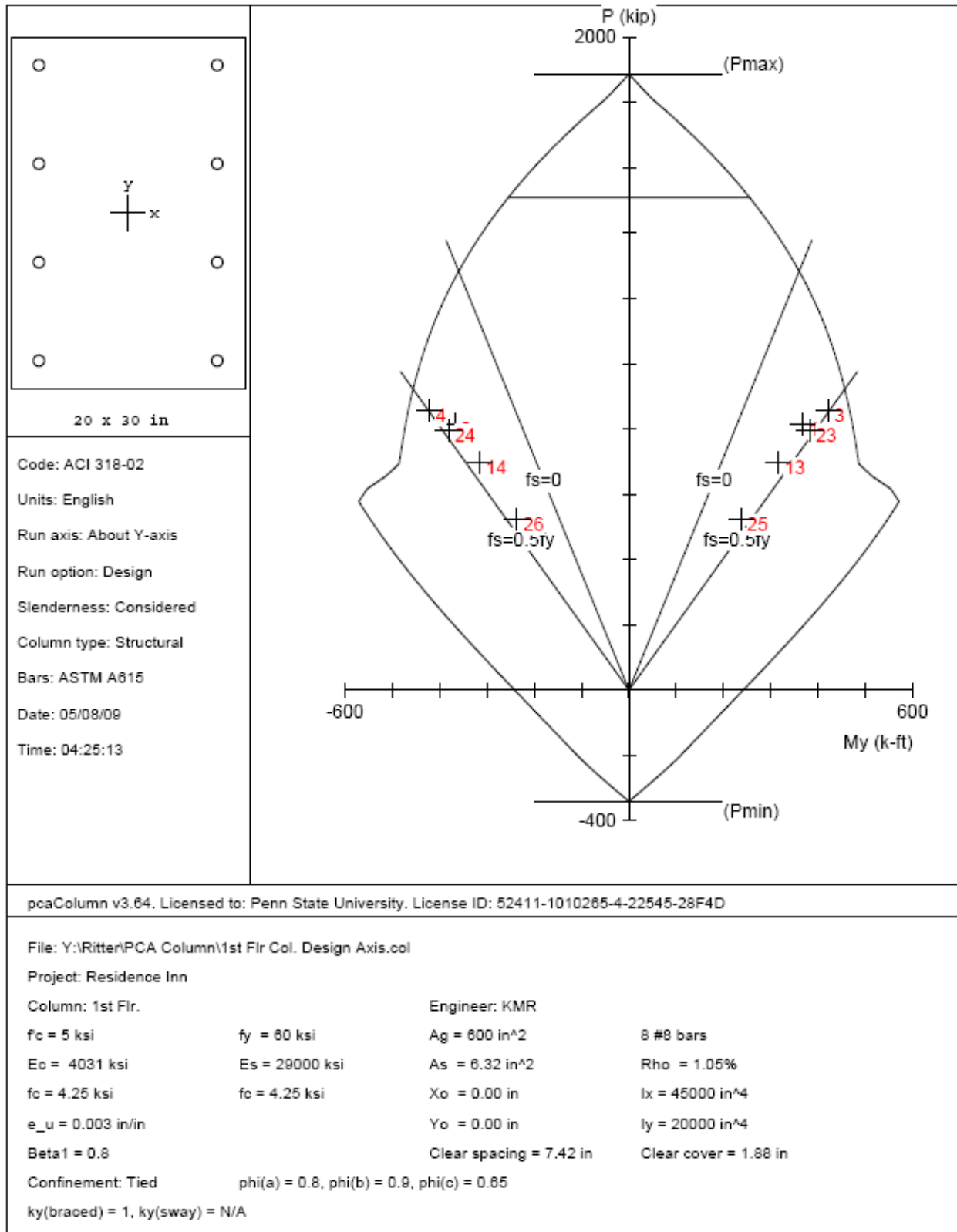

PCA COLUMN – 9 STORY ORIGINAL DESIGN RESULTS

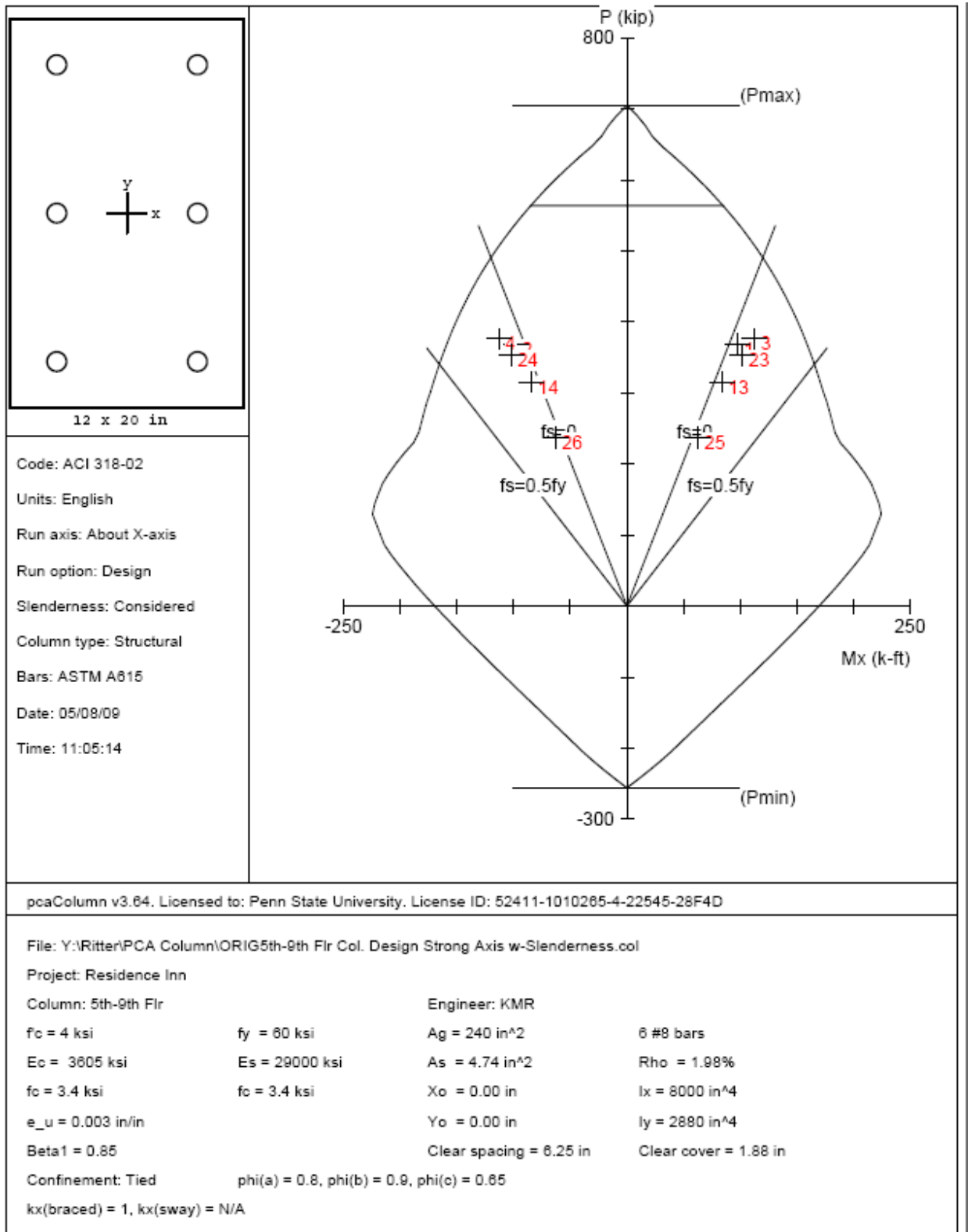

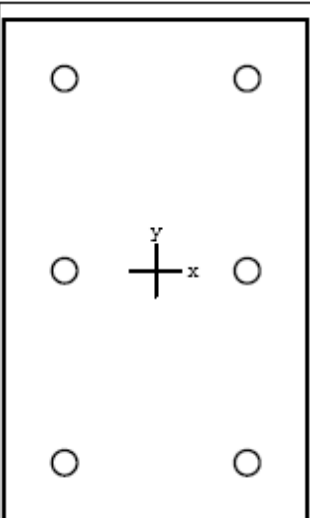

12 x 20 in

Code: ACI 318-02  
 Units: English  
 Run axis: About Y-axis  
 Run option: Design  
 Slenderness: Considered  
 Column type: Structural  
 Bars: ASTM A615  
 Date: 05/08/09  
 Time: 11:08:06

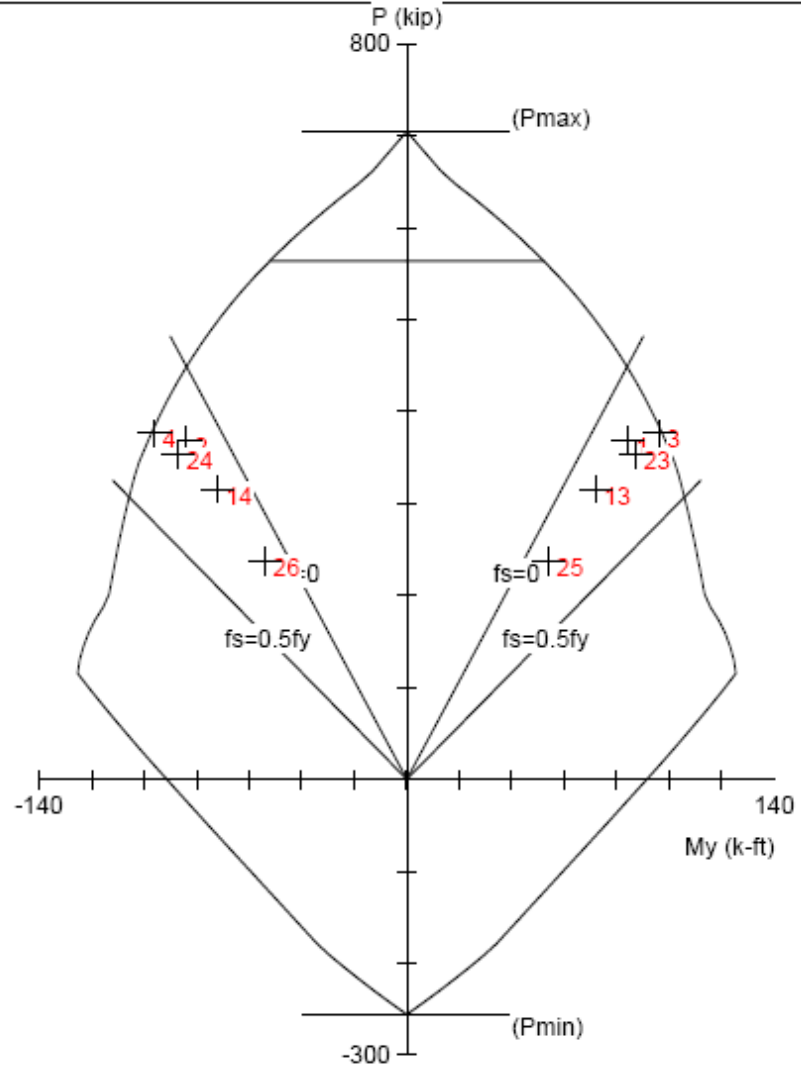

pcaColumn v3.64. Licensed to: Penn State University. License ID: 52411-1010265-4-22545-28F4D

File: Y:\Ritter\PCA Column\ORIG5th-9th Flr Col. Design Strong Axis w-Slenderness.col  
 Project: Residence Inn  
 Column: 5th-9th Flr  
 Engineer: KMR

$f_c = 4$ ksi	$f_y = 60$ ksi	$A_g = 240$ in <sup>2</sup>	6 #8 bars
$E_c = 3605$ ksi	$E_s = 29000$ ksi	$A_s = 4.74$ in <sup>2</sup>	Rho = 1.98%
$f_c = 3.4$ ksi	$f_c = 3.4$ ksi	$X_o = 0.00$ in	$I_x = 8000$ in <sup>4</sup>
$e_u = 0.003$ in/in		$Y_o = 0.00$ in	$I_y = 2880$ in <sup>4</sup>
Beta1 = 0.85		Clear spacing = 6.25 in	Clear cover = 1.88 in
Confinement: Tied	$\phi(a) = 0.8, \phi(b) = 0.8, \phi(c) = 0.65$		
$k_y(\text{braced}) = 1, k_y(\text{sway}) = \text{N/A}$			

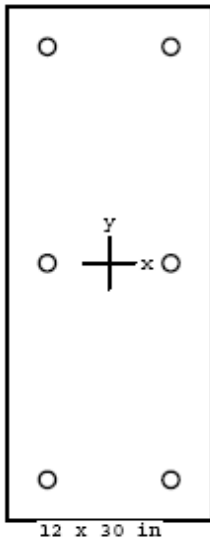

12 x 30 in

Code: ACI 318-02  
 Units: English  
 Run axis: About X-axis  
 Run option: Design  
 Slenderness: Considered  
 Column type: Structural  
 Bars: ASTM A615  
 Date: 05/08/09  
 Time: 11:21:37

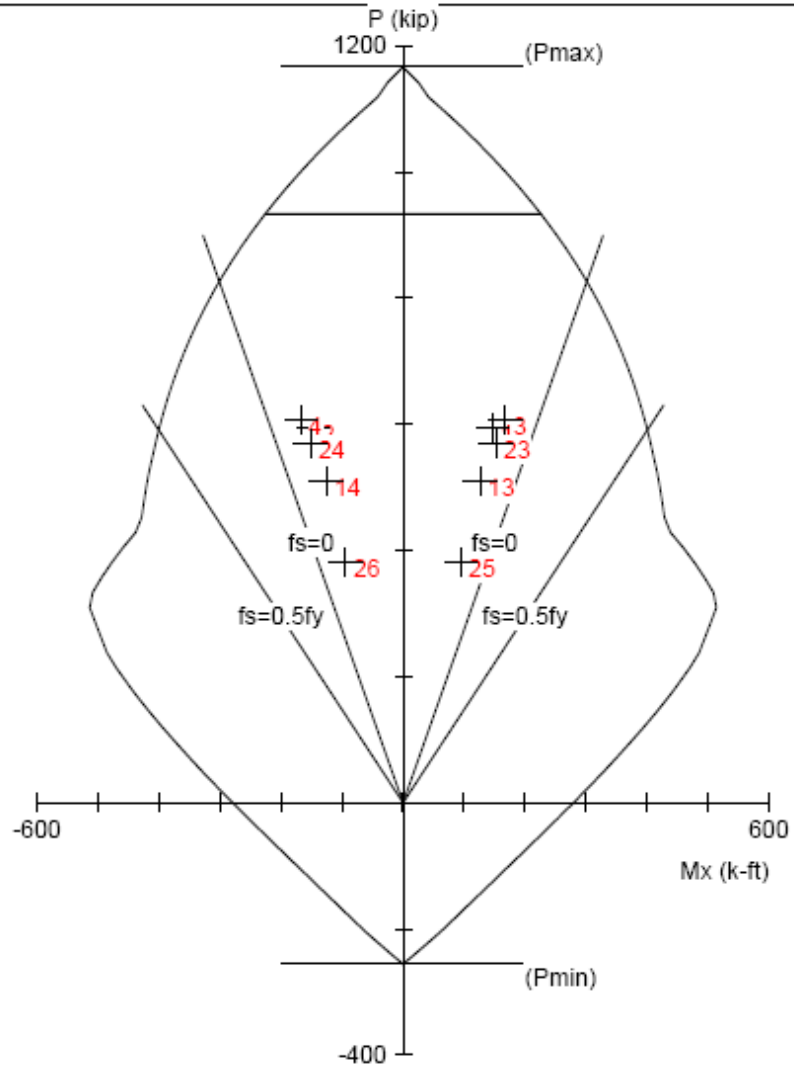

pcaColumn v3.64. Licensed to: Penn State University. License ID: 52411-1010285-4-22545-28F4D

File: Y:\Ritter\PCA Column\ORIG2nd-4th Flr Col. Design w-Slenderness.col

Project: Residence Inn

Column: 2nd-4th

Engineer: KMR

$f_c = 5$  ksi

$f_y = 60$  ksi

$A_g = 360$  in<sup>2</sup>

6 #8 bars

$E_c = 4031$  ksi

$E_s = 29000$  ksi

$A_s = 4.74$  in<sup>2</sup>

Rho = 1.32%

$f_c = 4.25$  ksi

$f_c = 4.25$  ksi

$X_o = 0.00$  in

$I_x = 27000$  in<sup>4</sup>

$e_u = 0.003$  in/in

$Y_o = 0.00$  in

$I_y = 4320$  in<sup>4</sup>

Beta1 = 0.8

Clear spacing = 6.25 in

Clear cover = 1.88 in

Confinement: Tied

$\phi(a) = 0.8, \phi(b) = 0.9, \phi(c) = 0.85$

$k_x(\text{braced}) = 1, k_x(\text{sway}) = \text{N/A}$

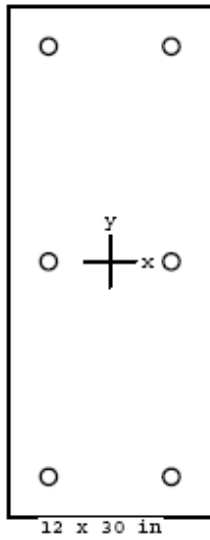

Code: ACI 318-02  
 Units: English  
 Run axis: About X-axis  
 Run option: Design  
 Slenderness: Considered  
 Column type: Structural  
 Bars: ASTM A615  
 Date: 05/08/09  
 Time: 11:22:33

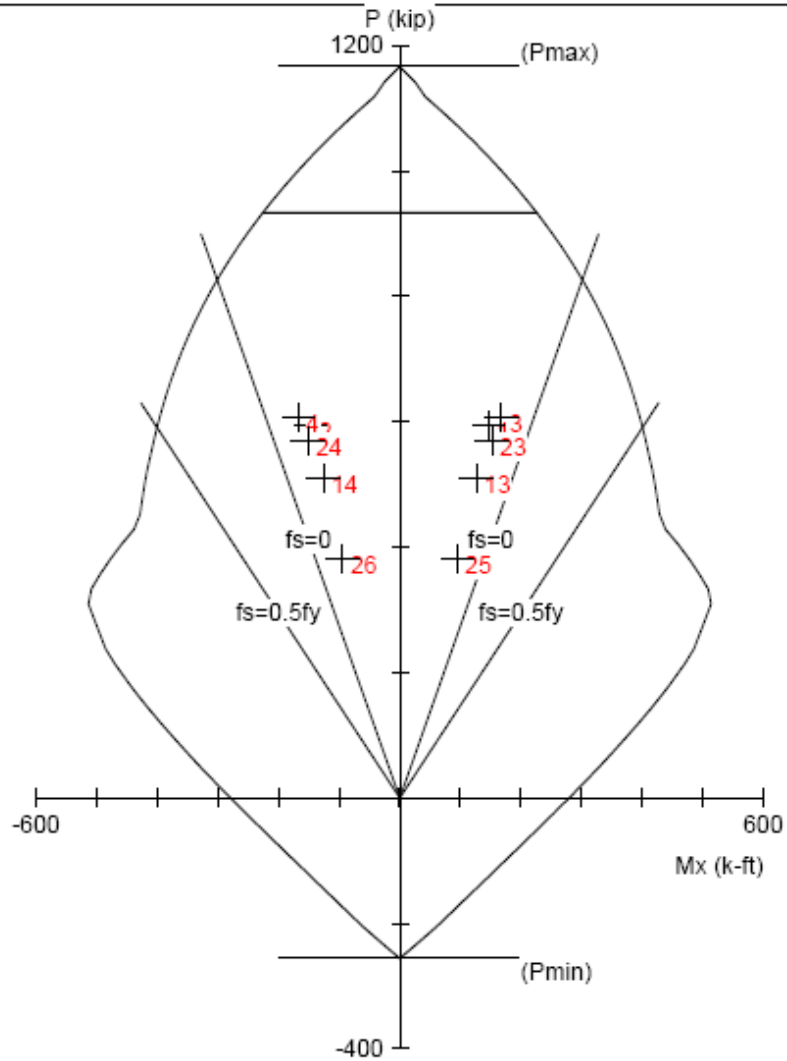

pcaColumn v3.64. Licensed to: Penn State University. License ID: 52411-1010285-4-22545-28F4D

File: Y:\Ritter\PCA Column\ORIG2nd-4th Flr Col. Design w-Slenderness.col

Project: Residence Inn

Column: 2nd-4th

Engineer: KMR

$f_c = 5$  ksi

$f_y = 60$  ksi

$A_g = 360$  in<sup>2</sup>

6 #8 bars

$E_c = 4031$  ksi

$E_s = 29000$  ksi

$A_s = 4.74$  in<sup>2</sup>

Rho = 1.32%

$f_c = 4.25$  ksi

$f_c = 4.25$  ksi

$X_o = 0.00$  in

$I_x = 27000$  in<sup>4</sup>

$e_u = 0.003$  in/in

$Y_o = 0.00$  in

$I_y = 4320$  in<sup>4</sup>

Beta1 = 0.8

Clear spacing = 6.25 in

Clear cover = 1.88 in

Confinement: Tied

$\phi(a) = 0.8, \phi(b) = 0.9, \phi(c) = 0.65$

$k_x(\text{braced}) = 1, k_x(\text{sway}) = \text{N/A}$

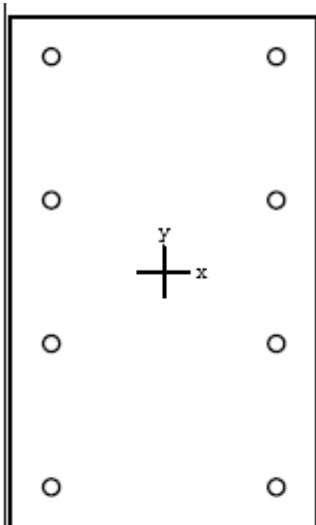

18 x 30 in

Code: ACI 318-02

Units: English

Run axis: About X-axis

Run option: Design

Slenderness: Considered

Column type: Structural

Bars: ASTM A615

Date: 05/08/09

Time: 11:28:35

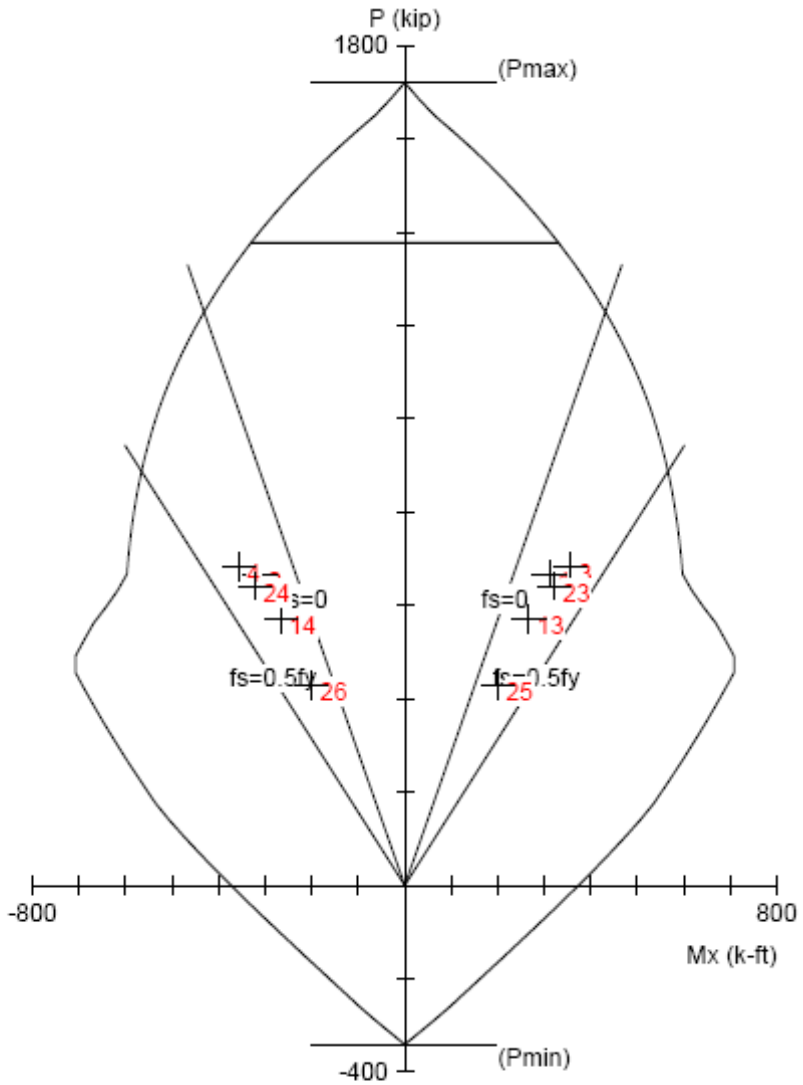

pcaColumn v3.64. Licensed to: Penn State University. License ID: 52411-1010265-4-22545-28F4D

File: Y:\Ritter\PCA Column\ORIG1st Flr Col. Design Axis.col

Project: Residence Inn

Column: 1st Flr.

Engineer: KMR

$f_c = 5$  ksi

$f_y = 60$  ksi

$A_g = 540$  in<sup>2</sup>

8 #8 bars

$E_c = 4031$  ksi

$E_s = 29000$  ksi

$A_s = 6.32$  in<sup>2</sup>

Rho = 1.17%

$f_c = 4.25$  ksi

$f_c = 4.25$  ksi

$X_o = 0.00$  in

$I_x = 40500$  in<sup>4</sup>

$e_u = 0.003$  in/in

$Y_o = 0.00$  in

$I_y = 14580$  in<sup>4</sup>

Beta1 = 0.8

Clear spacing = 7.42 in

Clear cover = 1.88 in

Confinement: Tied

$\phi(a) = 0.8, \phi(b) = 0.9, \phi(c) = 0.85$

$k_x(\text{braced}) = 1, k_x(\text{sway}) = \text{N/A}$

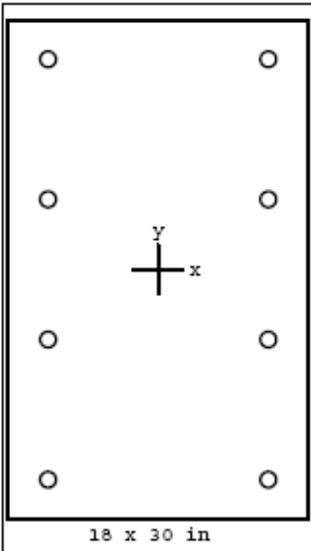

Code: ACI 318-02  
 Units: English  
 Run axis: About Y-axis  
 Run option: Design  
 Slenderness: Considered  
 Column type: Structural  
 Bars: ASTM A615  
 Date: 05/08/09  
 Time: 11:29:17

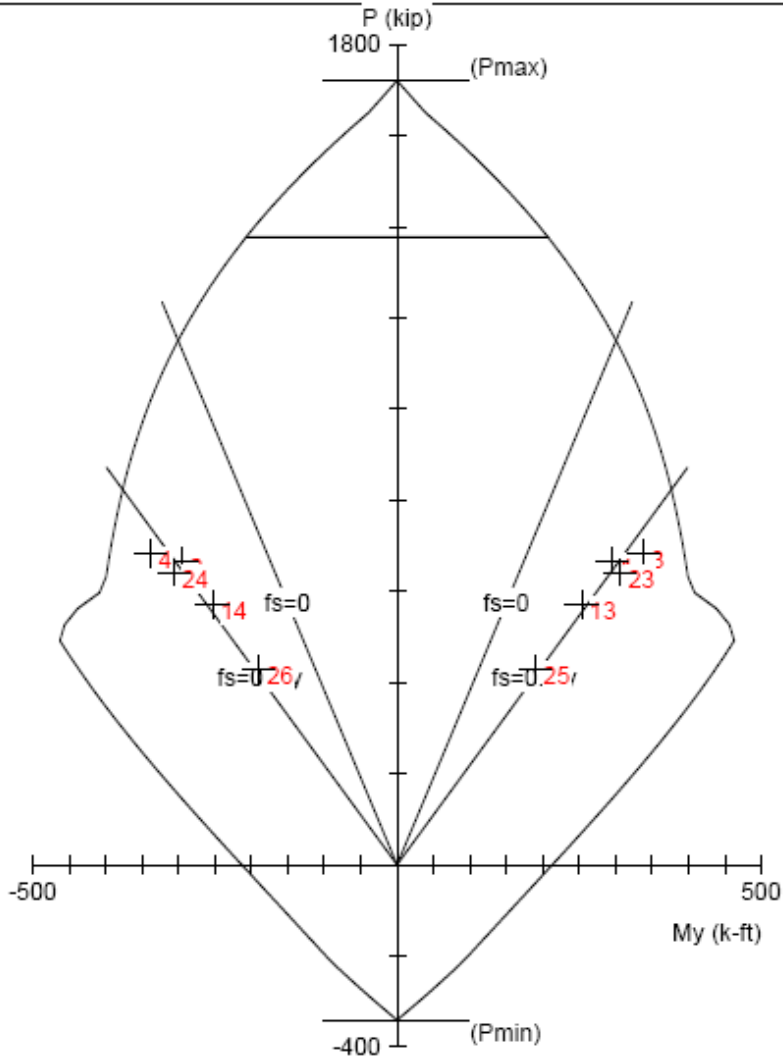

pcaColumn v3.64. Licensed to: Penn State University. License ID: 52411-1010285-4-22545-28F4D

File: Y:\Ritter\PCA Column\ORIG 1st Flr Col. Design Axis.col

Project: Residence Inn

Column: 1st Flr.

Engineer: KMR

$f_c = 5$ ksi	$f_y = 60$ ksi	$A_g = 540$ in <sup>2</sup>	8 #8 bars
$E_c = 4031$ ksi	$E_s = 29000$ ksi	$A_s = 6.32$ in <sup>2</sup>	Rho = 1.17%
$f_c = 4.25$ ksi	$f_c = 4.25$ ksi	$X_o = 0.00$ in	$I_x = 40500$ in <sup>4</sup>
$e_u = 0.003$ in/in		$Y_o = 0.00$ in	$I_y = 14580$ in <sup>4</sup>
Beta1 = 0.8		Clear spacing = 7.42 in	Clear cover = 1.88 in
Confinement: Tied	$\phi(a) = 0.8, \phi(b) = 0.9, \phi(c) = 0.85$		
$k_y(\text{braced}) = 1, k_y(\text{sway}) = \text{N/A}$			



## APPENDIX D: LATERAL SYSTEMS

### SEISMIC WEIGHT CALCULATION

MAIN ROOF				
Approximate Area:	12,202 SF			Height to Upper Roof: Varies
			West Stairwell	12'
			Penthouse	8.5'
			East Stairwell	6'
				ITEMIZED WEIGHT (k)
Mechanical Equipment				27.65
Allowance (PSF)				
Superimposed Allowances				
	Roofing	10		122.02
	MEP Hung Below	10		122.02
	MISC - Ducts, Pipes, Wear Course	5		61.01
Slab Self Weight				
	8" Reinf. Conc. Slab	100		1220.20
		Qty. (LF)	Weight (LB/FT)	
Concrete Columns				
	1 14"x24" @ W Stair	12	350	4.20
	1 14"x24" @ PH	8.5	350	2.98
	3 12"x24" @ PH	8.5	300	7.65
	1 24"x24" @ PH	8.5	600	5.10
Concrete Beams				
	12"x16"	14	200	2.80
	12"x20"	3	250	0.75
	36"x26"	11	975	10.73
	12"x24"	24	300	7.20
	24"x30"	23	750	17.25
	14"x16"	12	233.3	2.80
Shear Walls (1'-0" Thick, Typ.)				

	@ W Stair	28	1800	50.40
	@ PH	60	1275	76.50
	@ E Stair	52	900	46.80
Parapet Walls	(4'-6" HT, Typ.) Braced Metal Studs	654	46	30.08
Steel Framing	(Screen Walls)			
	HSS 7x7x5/16	34	27.54	0.94
	6" Dia. ES Pipe	60	28.6	1.72
	5" Dia. Std. Pipe	36	14.6	0.53
<b>TOTAL FLOOR WEIGHT (k)</b>				<b>1821.31</b>

FLOOR 11				
Approximate Area:				Floor-to-Floor Height
11,030 SF				12'
			Allowance (PSF)	ITEMIZED WEIGHT (k)
Superimposed Allowances				
	Floor Finishes	5		55.15
	MEP Hung Below	10		110.30
	Partitions	10		110.30
Slab Self Weight				
	10" Reinf. Conc. Slab	125		1378.75
			Qty. (LF)	Weight (LB/FT)
Concrete Columns				
47	14"x30"	12	437.5	246.75
Concrete Beams				
	12"x16"	44	200	8.80
	14"x16"	12	233.3	2.80
Shear Walls				
	1'-0" Thick	204	1800	367.20
	1'-2" Thick	22	2100	46.20

Exterior Walls	Curtain Wall	750	180	135.00
TOTAL FLOOR WEIGHT (k)				2461.25

FLOOR 10				
Approximate Area:			14,376 SF	Floor-to-Floor Height 12'
			Allowance (PSF)	ITEMIZED WEIGHT (k)
Superimposed Allowances				
	Floor Finishes	5		71.88
	MEP Hung Below	10		143.76
	Partitions	10		143.76
	Green Roof UDL	11	(45 psf ; 3,346 SF)	158.14
Slab Self Weight				
	10" Reinf. Conc. Slab	125		1797.00
			Qty. (LF)	Weight (LB/FT)
Concrete Columns				
	47	14"x30"	12	437.5
Concrete Beams				
		12"x16"	44	200
		14"x16"	12	233.3
Shear Walls				
	1'-0" Thick	204	1800	367.20
	1'-2" Thick	22	2100	46.20
Exterior Walls				
	Curtain Wall	750	180	135.00
TOTAL FLOOR WEIGHT (k)				3121.29

FLOORS 8-9					
Approximate Area:					Floor-to-Floor Height
14,376 SF					9.33'
				Allowance (PSF)	ITEMIZED WEIGHT (k)
Superimposed Allowances					
Floor Finishes				5	71.88
MEP Hung Below				10	143.76
Partitions				10	143.76
Slab Self Weight					
8" Reinf. Conc. Slab				100	1437.60
		Qty. (LF)	Weight (LB/FT)		
Concrete Columns					
56	14"x24"	9.33	350		182.87
2	14"x30"	9.33	437.5		8.16
Concrete Beams					
	12"x16"	44	200		8.80
	14"x16"	12	233.3		2.80
Shear Walls					
	1'-0" Thick	204	1399.5		285.50
	1'-2" Thick	22	1632.8		35.92
Exterior Walls					
	Curtain Wall	750	140		105.00
<b>TOTAL FLOOR WEIGHT</b>					
					<b>(k)</b>
					<b>2426.05</b>

FLOORS 3-7					
Approximate Area:					Floor-to-Floor Height
14,376 SF					9.33'
				Allowance (PSF)	ITEMIZED WEIGHT (k)
Superimposed Allowances					
Floor Finishes				5	71.88

MEP Hung Below		10		143.76
Partitions		10		143.76
Slab Self Weight				
8" Reinf. Conc. Slab		100		1437.60
		Qty. (LF)	Weight (LB/FT)	
Concrete Columns				
58	14"x30"	9.33	437.5	236.75
Concrete Beams				
	12"x16"	44	200	8.80
	14"x16"	12	233.3	2.80
Shear Walls				
	1'-0" Thick	204	1399.5	285.50
	1'-2" Thick	22	1632.8	35.92
Exterior Walls				
	Drainable EIFS	750	140	105.00
<b>TOTAL FLOOR WEIGHT</b>				
(k)				<b>2471.77</b>

FLOOR 2				
Approximate Area:				Floor-to-Floor Height
	14,376	SF		9.33'
Canopies	650	SF		
				ITEMIZED WEIGHT (k)
Canopy Steel Framing (Wide Flanges)				16.96
		Allowance (PSF)		
Canopy Roof		10		6.5
Superimposed Allowances				
	Floor Finishes	5		71.88
	MEP Hung Below	10		143.76
	Suspended Ceiling Below	0		0.00

	Partitions	10		143.76
Slab Self Weight	8" Reinf. Conc. Slab	100		1437.60
		Qty. (LF)	Weight (LB/FT)	
Concrete Columns				
58	14"x30"	19	437.5	482.13
Concrete Beams				
	12"x16"	42	200	8.40
	8"x8"	2	66.7	0.13
	14"x16"	16	233.3	3.73
Concrete Transfer Girders				
	48"x36"	26	1800	46.80
	48"x48"	70	2400	168.00
	48"x44"	28	2200	61.60
	48"x54"	30	2700	81.00
	36"x48"	57	1800	102.60
	30"x48"	9	1500	13.50
	36"x36"	12	1350	16.20
	72"x54"	55	4050	222.75
	60"x54"	30	3375	101.25
Shear Walls				
	1'-0" Thick	204	1399.5	285.50
	1'-2" Thick	22	1632.8	35.92
Exterior Walls				
	Drainable EIFS	750	140	105.00
<b>TOTAL FLOOR WEIGHT</b>				
(k)				<b>3554.97</b>

MECHANICAL MEZZANINE	
Approximate Area:	Floor-to-Floor Height
1,576 SF	10.33'
Allowance (PSF)	ITEMIZED WEIGHT (k)
Superimposed Allowances	

	Floor Finishes		5		7.88
	MEP Hung Below		10		15.76
	Mech. Equipment		10		15.76
Slab Self Weight					
	8" Reinf. Conc. Slab		100		157.60
				Qty. (LF)	Weight (LB/FT)
Concrete Columns					
	58	20"x30"	10.33	625	374.46
	7	20"x24"	10.33	500	36.16
Concrete Beams					
		24"x18"	76	450	34.20
		30"x18"	116	562.5	65.25
		30"x22"	22	687.5	15.13
		26"x22"	22	595.8	13.11
		20"x18"	25	375	9.38
Shear Walls					
		1'-0" Thick	204	1399.5	285.50
		1'-2" Thick	22	1632.8	35.92
Exterior Walls					
	Arch. Precast/Drainable EIFS		750	210	157.50
<b>TOTAL FLOOR WEIGHT (k)</b>					<b>1223.59</b>

SEISMIC LOAD CALCULATION ASSUMPTIONS & FACTORS

SEISMIC LOADS	RESIDENCE INN	KMR	1/2
<p><u>REFERENCES</u> : ASCE 7-05 IBC 2006</p>			
<p><u>ASSUMPTIONS</u> : SITE CLASS D</p> <p><math>S_s = 0.5</math> <math>S_1 = 0.15</math> } CRITERIA SET FOR DEVELOPMENT OF PROTOTYPE</p>			
<p><u>SITE COEFF'S</u> : <math>F_a = 1.4</math> (BASED ON SITE CLASS D / <math>S_s = 0.5</math>) <math>F_v = 2.2</math> (BASED ON SITE CLASS D / <math>S_1</math>, BETW. 0.1 &amp; 0.2 - LIN. INTERP.)</p>			
<p><u>ADJ. MCE SPECTRAL RESP. ACCEL. :</u></p> <p><math>S_{ms} = F_a S_s = (1.4)(0.5) = 0.7</math> s <math>S_{m1} = F_v S_1 = (2.2)(0.15) = 0.33</math> s</p>			
<p><u>DESIGN SPECTRAL ACCEL. :</u></p> <p><math>S_{DS} = 2/3 S_{ms} = 2/3 (0.7) = 0.467</math> s <math>S_{D1} = 2/3 S_{m1} = 2/3 (0.33) = 0.22</math> s</p>			
<p><u>IMPORTANCE FACTOR</u> : I = 1.0 (OCCUPANCY TYPE II)</p>			
<p><u>SDC</u> → BASED ON <math>S_{DS}</math> [0.33 ≤ <math>S_{DS}</math> ≤ 0.50 ; OCC. II] → SDC-C → BASED ON <math>S_{D1}</math> [0.20 ≤ <math>S_{D1}</math> ; OCC. II] → <b>SDC-D</b> ← CRITICAL</p>			
<p><u>APPROX. PERIOD</u></p> <p><math>T_a = C_t h_n^x</math> ; <math>C_t = 0.02</math> [TBL. 12.8-2, "ALL OTHER STRUCT. SYSTEMS"] <math>x = 0.75</math> <math>h_n = 129.67'</math></p> <p><math>= (0.02)(129.67)^{0.75} = \underline{0.769 \text{ sec.}}</math> * IDENTIFY MORE CRITICAL PERIOD W/ COMP. MODEL TO DETERMINE STORY FORCES</p>			
<p><u>ACTUAL PERIOD</u> : (USING ETABS MODEL)</p> <p><math>T_x = 1.077</math> sec. [MODE 2] <math>T_y = 1.436</math> sec. [MODE 1] <math>T_z = 0.857</math> sec. [MODE 3] ← CONTROLS</p>			



X-DIREC.

FUNDAMENTAL PERIOD, T : [BASED ON  $S_{D1} = 0.22s$ ; TBL. 12.8-1]

$$T = \text{MIN} \begin{cases} C_u \cdot T_a = 1.48 (0.769s) = 1.138s. \\ T_b = \boxed{1.077s.} \quad \text{USE THIS ONE} \end{cases}$$

$$C_s = \text{MIN} \begin{cases} S_{DS}/(\frac{R}{I}) = 0.407/(\frac{4}{1}) = 0.0778 \\ S_{D1}/T(\frac{R}{I}) = 0.22/1.077(\frac{4}{1}) = \underline{0.0340} \\ S_{D1}T_L/T^2(\frac{R}{I}) : \text{DOES NOT APPLY [T < T}_L = \overset{\text{RANGE}}{4-16}] \end{cases}$$

$$R = 6 \quad [TBL. 12.2-1 ; \text{SPECIAL REINF. CONC. SHEAR WALLS}] \\ I = 1.0$$

BASE SHEAR (X-DIR.)

$$V_{bx} = C_s \cdot W = 0.0340 (28,292.57^k) = \boxed{963^k}$$

Y-DIREC.

FUNDAMENTAL PERIOD, T :

$$T = \text{MIN} \begin{cases} C_u \cdot T_a = 1.48 (0.769s) = \boxed{1.138s.} \quad \text{USE THIS ONE} \\ T_b = 1.436 \end{cases}$$



$$C_s = \text{MIN} \begin{cases} S_{DS}/(\frac{R}{I}) = 0.0778 \\ S_{D1}/T(\frac{R}{I}) = 0.22/(1.138)(\frac{4}{1}) = \underline{0.0322} \\ S_{D1}T_L/T^2(\frac{R}{I}) : \text{DOES NOT APPLY [T < T}_L = \overset{\text{RANGE}}{4-16}] \end{cases}$$

BASE SHEAR (Y-DIR.)

$$V_{by} = C_s \cdot W = 0.0322 (28,292.57^k) = \boxed{911^k}$$

\*SEE SPREADSHEET FOR DISTRIB'S TO EA. FLOOR  $\frac{1}{2}$  MOM'S GENERATED BY ACCIDENTAL TORSION.

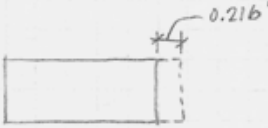
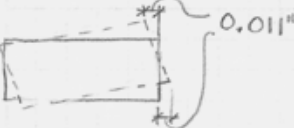
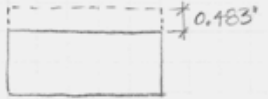
STRUCTURAL IRREGULARITY CHECKS

HORIZ. STRUCTURAL IRREGULARITY CHK.	RESIDENCE INN	KMR 1/2
<p>TYPE 1a : <u>TORSIONAL IRREG.</u> / ETI (1b) <sup>MAKE SEVERE</sup></p> <p>X-DIR. LOADING :</p> <p>DISPL. DUE TO DIRECT SHEAR LOAD CASE : [SEISMIC X] </p> <p>DISPL. DUE TO 5% ACCID. TORSION LOAD CASE : [SEISMIC ZX] </p> <p><math>\delta_{max} = 0.216'' + 0.011'' = 0.227''</math> <sup>(SW-7)</sup></p> <p><math>\delta_{avg} = \frac{(0.216'' + 0.157'')}{2} = 0.1865''</math> <sup>@ opp. end (SW-4)</sup></p> <p><math>\frac{\delta_{max}}{\delta_{avg}} = \frac{0.227''}{0.1865''} = 1.22 &gt; 1.2 &lt; 1.4 \therefore</math> <b>TORSIONAL IRREG. TYPE 1a EXISTS</b></p> <p>Y-DIR. LOADING :</p> <p>DISPL. DUE TO DIRECT SHEAR LOAD CASE : [SEISMIC Y] </p> <p>DISPL. DUE TO 5% ACC. TORSION LOAD CASE : [SEISMIC ZY] </p> <p><math>\delta_{max} = 0.483 + 0.075'' = 0.558''</math></p> <p><math>\delta_{avg} = \frac{0.483 + 0.166}{2} = 0.3245''</math></p> <p><math>\frac{\delta_{max}}{\delta_{avg}} = \frac{0.558''}{0.3245''} = 1.72 &gt; 1.2 &gt; 1.4 \therefore</math> <b>TORSIONAL IRREG. TYPES 1a/1b EXIST</b></p> <p><math>\therefore</math> *TORS. AMPL. FACTOR NEEDED (<math>A_x</math>) *ELF NOT PERMITTED ; MUST PERFORM MODAL ANALYSIS.</p>		

Type 2 : REENTRANT CORNERS

- BY INSPECTION, FLRS 1-10, THIS IS NOT AN ISSUE
- FLRS 11 & ROOF :

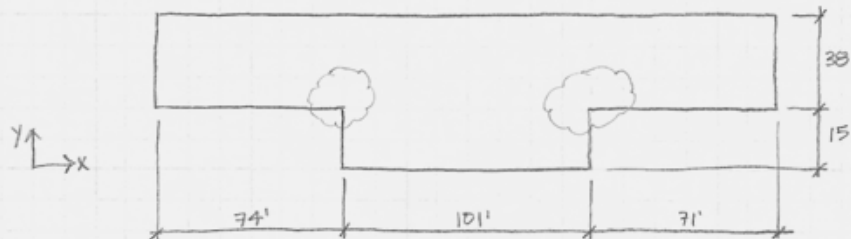

X-DIREC.  $\frac{74' + 71'}{74 + 101 + 71} = \frac{145'}{246'} = 0.59 > 0.15 \therefore$  IRREG. EXISTS

Y-DIREC.  $\frac{15'}{38' + 15'} = \dots 0.28 > 0.15 \therefore$  IRREG. EXISTS

Type 3 : DIAPHRAGM DISCONTINUITY

Type 4 : OUT-OF-PLANE OFFSETS

Type 5 : NONPARALLEL SYSTEMS

} BY INSPECTION, DNE

→ \* B/C A HORIZ. IRREG. EXISTS, DIAPHRAGM SHOULD BE CHECKED FOR SEMI-RIGID BEHAVIOR.

[PER 12.3.1.2]

TYPE 1a/1b : SOFT STORY / ESS

IN ETABS, CHECK DIFF. BETW. 1<sup>ST</sup> & 2<sup>ND</sup> FLRS :

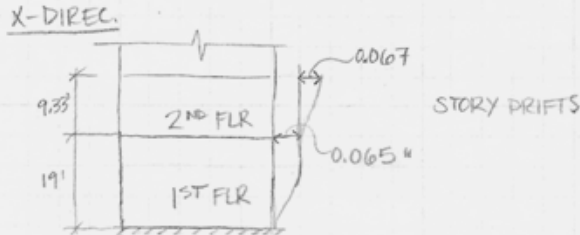

$$\frac{\Delta_{s1}}{h_1} = \frac{0.065}{(19 \times 12)} = 0.000286$$

$$\frac{\Delta_{s2}}{h_2} = \frac{0.065}{(9.33 \times 12)} = 0.000594$$

STORY DRIFT RATIOS

FOR TYPE 1a :

$$0.7(0.000286) = 0.0002 < 0.000594 \therefore$$

SOFT STORY/ESS  
IRREG.  
DOES NOT  
EXIST

Y-DIREC.

$$\frac{\Delta_{s1}}{h_1} = 0.000438$$

$$\frac{\Delta_{s2}}{h_2} = 0.000961$$

$$0.7(0.000438) = 0.000307 < 0.000961 \therefore$$

SOFT STORY/ESS  
IRREG.  
DOES NOT  
EXIST

TYPE 2 : MASS IRREG.

BASED ON SEISMIC WEIGHTS, MOST CRITICAL FLR. TO  
CHECK IS :

$$\begin{matrix} 2^{ND}: & 3554.97^k \\ 3^{RD}: & 2471.77^k \end{matrix}$$

$$\Rightarrow \frac{3554.97}{2471.77} = 1.44 < 1.5 \therefore$$

MASS IRREG.  
DOES NOT  
EXIST

→ BY INSPECTION, TYPES 3, 4, 5a, 5b DO NOT EXIST.

SHEAR WALL RE-DESIGN CALCULATIONS

SW-4	SHEAR WALL DESIGN	RESIDENCE INN	KMR	1/5
------	-------------------	---------------	-----	-----

**SW-4**

[ACI 21.9]

$F_y = 60,000 \text{ psi}$

$f'_c, \text{avg} = \frac{71(4) + 47(5)}{118} = 4.4 \text{ ksi}$

$P_u$ :

SELF-WT :  $(1' \times 118' \times 42.16') (150 \text{ PCF}) = 746^k$

D + L :

TRIB =  $11' \times 42.16' = 464 \text{ SF/FLR}$

DEAD : 2<sup>ND</sup> → 9<sup>TH</sup> FLRS (8 FLRS) = 125 PSF  
 10<sup>TH</sup> = 161 PSF  
 11<sup>TH</sup> = 150 PSF  
 ROOF = 125 PSF + 3600 lb EQUIP.

=  $464 ( 9(125) + 161 + 150 ) + 3600 = 670^k$

LIVE : 2<sup>ND</sup> → 9<sup>TH</sup> FLRS (8 FLRS) = 40 PSF  
 10<sup>TH</sup> → 11<sup>TH</sup> FLRS (2 FLRS) = 80 PSF × 0.5 = 40 PSF  
 ROOF = 30 PSF

=  $464 ( 10(40) + 30 ) = 200^k$

LC'S : (5)EX :  $(1.2 + 0.2S_{DS})D + \rho Q_E + L + 0.2S$

↳  $P_u = 1100^k + (1.2 + 0.2(0.467))(670^k) + 200^k + 0.2(13.9^k)$

↑  
FROM ETABS LAT. ANALYSIS

$P_u = 2169^k$  ← governs

SW-4	SHEAR WALL DESIGN	RESIDENCE INN	KMR	2/5
------	-------------------	---------------	-----	-----

LC'S CONT'D ...

$$(7) \text{ EX : } (0.9 - 0.25 D_S) D + \rho Q_E + 1.6 H \rightarrow 0$$

$$P_u = (0.9 - 0.2(0.467))(670^k) + 1100^k$$

$$= 1640^k$$

→ CHECK IF BOUNDARY ELEMENTS REQ'D:

- WALL IS NOT CONTINUOUS FROM BASE → TOP (IE. THERE ARE OPENINGS) ∴ NEED B.E.'S IF:

$$f_c = \frac{P_u}{A_g} \pm \frac{M_u y}{I_g} \geq 0.2 f'_c \quad I_g = \frac{(12)(506)^3}{12} = 129,554,216 \text{ in}^4$$

$$= \frac{2169^k}{(12 \times 506)} + \frac{51,115^k (12 \text{ in}) (506/2)}{129,554,216 \text{ in}^4}$$

$$= 0.357 + 1.198 = 1.56 \text{ ksi} > 0.2(4.4 \text{ ksi}) = 0.88 \text{ ksi}$$

∴ B.E.'S REQ'D

→ ? If increase thickness of wall, would need  $I_g \approx 282,000,000$

$$t \frac{(506)^3}{12} = 282,000,000 \Rightarrow t = 26''$$

↑ NOT PRACTICAL

$$\frac{M_u}{\text{arm}} = \frac{51,115^k}{42.16'} = 20.21 \text{ in}^2 = A_{S, \text{TRIAL}}$$

→ TRY (16) # 10's →  $A_s = 20.3 \text{ in}^2$ ,  $D = 1.27''$

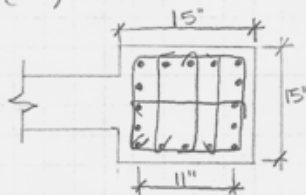

MIN. SPACING =  $d_b = 1.27''$  ~ USE 1.5" CLR  
CLR COVER MIN. = 0.75" FOR WALLS NO WEATH.

$$0.75'(2) + 5(1.27'') + 4(1.5') + 2(0.2) = 14.25''$$

→ TRY 15" x 15" ↑ # TIES / HOOKS

→ AXIAL LOAD CAPACITY (SHORT COL.) - B.E.

$$\begin{aligned}\phi P_n &= 0.8 \phi [0.85 f'_c (A_g - A_{st}) + f_y A_{st}] \geq C_u \\ &= 0.8(0.65) [0.85(4.4)((15" \times 15") - 20.3 \text{ in}^2) + 60(20.3)] \\ &= 1031 \text{ k}\end{aligned}$$

$$C_u = \frac{P_u}{2} + \frac{M_u}{d} = \frac{2169}{2} + \frac{5115}{42.16'} = 2297 \text{ k} > \phi P_n \therefore \underline{\text{NG}}$$

∴ NEED TO INCREASE  $A_g$  OF B.E.

→ TRY 40" x 24" ⇒  $\phi P_n = 2461 \text{ k} > C_u \therefore \underline{\text{OK}}$

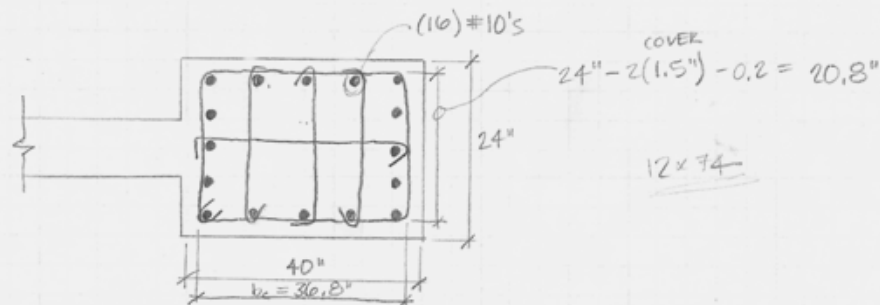

→ TRANSVERSE & LONG. REINF.

IF  $V_u \geq 2A_{cv} \sqrt{f'_c} \Rightarrow$  NEED 2 CURTAINS

$$V_u = 640 \text{ k} < 2 \left( \underbrace{12" \times (506" + 12" + 40")}_{A_{cv} = 598"} \right) \sqrt{4400}/1000 = 888 \text{ k}$$

∴ ONLY (1) CURTAIN NEEDED.

REQ'D  $\rho_l \leq \rho_t$  BASED ON MIN. REQ'D MNT

$$\text{MIN } \rho_l, \rho_t = \frac{2A_{cv}}{t \cdot s} = \frac{A_{sl}}{A_{cu}} \geq 0.0025$$

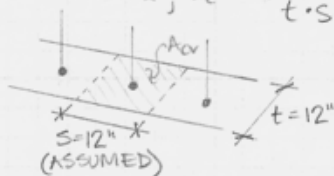

$$A_{cv} = 12" \times 12" = 144 \text{ in}^2$$

$$A_{sl} = (144 \text{ in}^2)(0.0025) = 0.36 \text{ in}^2/\text{ft}$$

→ TRY #6 IN (1) CURTAIN

$$A_{sl} = 0.44 \text{ in}^2 > 0.36 \text{ in}^2 \text{ (REQ'D)}$$

SW-4	SHEAR WALL DESIGN	RESIDENCE INN	KMR	4/5
$\frac{0.36 \text{ in}^2/\text{ft}}{12"} = \frac{0.44 \text{ in}^2}{s} \Rightarrow s_{\text{req'd}} = 14.7" < s_{\text{max}} = 18" \quad [12.9, 2.1] \quad \underline{\text{OK}}$ $\Rightarrow \underline{s = 14"} $ $\rho_e \leq \rho_t = \boxed{\#6 @ 14" \text{ EW}}$				
<p>→ CHECK SHEAR CAPACITY:</p>				
$\phi V_n = 0.75 [A_{cv} (\alpha_c \sqrt{f'_c} + \rho_t f_y)] / 1000$ $= 0.75 [558 (2.0 \sqrt{4400} + 0.00524 (60000))] / 1000 = 187^k$				
$\hookrightarrow \frac{h_w}{l_w} = \frac{118'}{42.16'} = 2.8 > 2 \therefore \alpha_c = 2.0$				
$\hookrightarrow \rho_t = \frac{2A_v}{t \cdot s} = \frac{2(0.44 \text{ in}^2)}{12" (14")} = 0.00524$				
$\phi V_n = 187^k < V_u = 640^k \therefore \underline{\text{NG}}$				
<p>→ TRY 2 CURTAINS #6 @ 12" EW</p>				
$\rho_t = \frac{2(2(0.44 \text{ in}^2))}{12" (12")} = 0.0122$				
$\phi V_n = 0.75 [558 (2 \sqrt{4400} + 0.0122 (60000))] / 1000 = 362^k$ $< V_u = 640^k$ $\therefore \underline{\text{NG}}$				
<p>→ TRY 2 CURTAINS #9 @ 12" EW</p>				
$\rho_t = \frac{2(2(1.00 \text{ in}^2))}{12" (12")} = 0.0278$				
$\phi V_n = 0.75 [558 (2 \sqrt{4400} + 0.0278 (60000))] / 1000 = 753^k$ $> V_u = 640^k$ $\therefore \underline{\text{OK}}$				
<p>→ CHECK BOUNDARY ELEMENT CAPACITY:</p>				
$A_s = 16(1.27 \text{ in}^2) = 20.32 \text{ in}^2$				
$\rho_{st} = \frac{20.32}{24 \times 40} = 0.0212$				
$\rho_{\text{min}} = 0.01 < \rho_{st} = 0.0212 < \rho_{\text{max}} = 0.06 \quad \checkmark \underline{\text{OK}}$				



→ HOOP REINF. DESIGN FOR B.E.

REQ'D AREA :

$$A_{sh} \geq \begin{cases} 0.09 s b_c \frac{f'_c}{f_{yh}} = 0.09(6)(36.8) \left(\frac{4.4}{60}\right) = \underline{1.46 \text{ in}^2} \\ 0.3 s b_c \left(\frac{A_g}{A_{ch}} - 1\right) \frac{f'_c}{f_{yh}} = 0.3(6)(36.8) \left(\frac{24 \times 10}{20.8 \times 36.8} - 1\right) \left(\frac{4.4}{60}\right) = 1.28 \text{ in}^2 \end{cases}$$

governs

$A_{s, provided} = 5(0.31 \text{ in}^2) = 1.55 \text{ in}^2 > A_{sh, min} = 1.46 \text{ in}^2 \therefore \underline{OK}$

$$S_{max, vert} \leq \frac{1}{4} \text{ min. dim.} = \frac{24}{4} = 6''$$

$$l_{db} = 6(1.27 \text{ in}) = 7.62''$$

$$S_o = 4'' \leq \left(4 + \frac{14 - h_x}{3}\right) \leq 6''$$

$$\left(4 + \frac{14 - 9}{3}\right) = 6''$$

→ CHOOSE S = 6" (VERT. SPACING OF HOOPS)

→ USE (5) #5 TIES @ 6" VERT. SPACING

% MAT'L INCR.

78% CF MORE CONC.

ORIG. WALL DES. = 4956 CF CONC

16% INCR. CONC.

353 TIES (#6)

$$\left. \begin{array}{l} \text{OUTER} = 9.5 \text{ LF} \\ \text{INNER} = 5.3 \text{ LF} \end{array} \right\} 14.8 \text{ LF} \times 353 = 5236 \text{ LF} @ 1.502 \text{ lb/ft} = 7865 \text{ lb}$$

LONG. (#10)

$$16(120') = 1920 \text{ LF} \times 4.303 \text{ lb/ft} = 8262 \text{ lb}$$

16,127 lb EXTRA

ORIG.

$$\left. \begin{array}{l} 41 \text{ VERT. } \#4, 75' \\ 74 \text{ HORIZ. } \#4, 42' \end{array} \right\} \times 0.668 = 4130 \times 2 = 8260 \text{ lb}$$

$$\left. \begin{array}{l} 41 \text{ VERT. } \#6, 43' \\ 42 \text{ HORIZ. } \#6, 42' \end{array} \right\} \times 1.502 = 5298 \times 2 = 10,595 \text{ lb}$$

$$8260 \text{ lb} + 12000 = \underline{30,855 \text{ lb}}$$

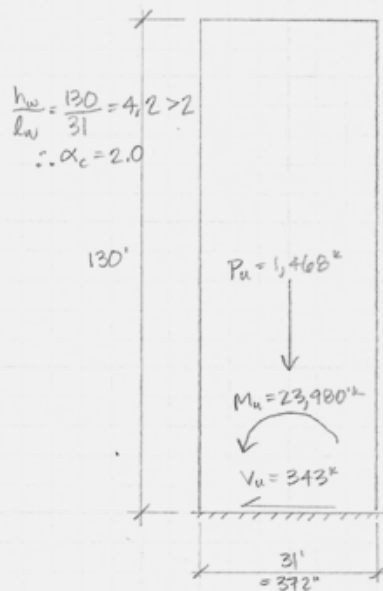

ACI, CH. 21

$$F_y = 60 \text{ ksi}$$

$$f'_c = 5 \text{ ksi}$$

ASSUMPTIONS:  
 OPENINGS NEGLECTIBLE  
 12" THICKNESS

$$I_g = \frac{(12")(372")^3}{12} = 51,478,848 \text{ in}^4$$

$$A_g = (12")(372") = 4464 \text{ in}^2$$

$$y = \frac{372}{2} = 186"$$

$$f_c = \frac{1468}{4464} \pm \frac{23980(12)(186)}{51,478,848}$$

$$= 0.329 \pm 1.04 = 1.37 > 0.2(5 \text{ ksi}) = 1 \text{ ksi}$$

$\therefore$  B.E. NEEDED

$\rightarrow$  TRY 14" THICK WALL TO ELIM. NEED FOR B.E.'S

$$A_g = 5,208 \text{ in}^2$$

$$I_g = 60,058,656 \text{ in}^4$$

$$\Rightarrow f_c = 0.28 + 0.89 = 1.17 > 1.0$$

NG

### B.E. DESIGN

$$A_{s, \text{TRIAL}} = \frac{M_u}{\frac{\text{arm}}{F_y}} = \frac{23,980^k}{\frac{31'}{60 \text{ ksi}}} = 12.9 \text{ in}^2$$

$$(14) \#9 \rightarrow A_s = 14 \text{ in}^2, \rho_{st} = \frac{14}{28 \times 18} = 0.028 > 0.01 < 0.06 \quad \checkmark \text{ OK}$$

$$C_u = \frac{P_u}{2} + \frac{M_u}{d} = \frac{1468}{2} + \frac{23,980}{31} = 1508^k$$

$$C_u \leq \phi P_n = 0.8(0.65) [0.85(5)(A_g - 14) + 60(14)] \geq 1508$$

$$\Rightarrow A_g \geq 499 \text{ in}^2 \sim 42 \times 12$$

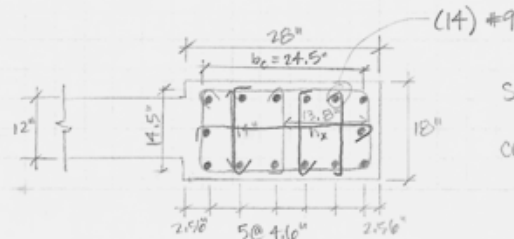

$$\text{SPACING} = 4.16" > d_b = 1.125" \quad \checkmark \text{ OK}$$

$$\text{COVER} = 1.5"$$

TRANSVERSE & LONGT. REINF.

$$2A_{cv} \sqrt{f'_c} = 2 \left( 12'' \times \frac{A_{cv}}{5141} \times 12''/ft \right) \sqrt{5000} / 1000 = 726^k > 343^k$$

∴ 2 CURTS NR

TYP. → #4 @ 12" EF, EN & CHECK < 18" MAX SPACING ✓ OK

$$\rho_t = \frac{2A_v}{t \cdot s} = \frac{2(0.2 \text{ in}^2)}{(12'')(12'')} = 0.00278 > 0.0025 \checkmark \text{ OK}$$

$$\phi V_n = 0.75 \left[ 5141 \left( 2\sqrt{5000} + 0.00278(60000) \right) \right] / 1000 = 1188^k$$

$$\phi V_n > V_u = 343^k \therefore \underline{\underline{\text{OK}}}$$

HOOPS

$$s_{max} \leq \frac{1}{4} \text{ MIN DIM B.E.} = \frac{1}{4}(18'') = 4.5''$$

$$6d_b = 6(1.128'') = 6.77''$$

$$s_o = 4 + \left( \frac{14 - 13.8}{3} \right) = 4.07'' \rightarrow \text{USE } 4'' \text{ SPACING (VERT)}$$

$$A_{sh} \geq 0.09(4')(24.5'') \left( \frac{5}{60} \right) = 0.735 \text{ in}^2$$

$$0.3(4')(24.5'') \left[ \left( \frac{28 \times 18}{24.5 \times 14.5} \right) - 1 \right] \left( \frac{5}{60} \right) = \underline{\underline{1.03 \text{ in}^2}} \text{ GOVERNS}$$

$$A_{s,prov.} = 6(0.2 \text{ in}^2) = 1.20 \text{ in}^2 > 1.03 \text{ in}^2 \therefore \underline{\underline{\text{OK}}}$$

↑ #4

(6) #4 TIES @ 4" VERT. SPACING.

$$\frac{h_w}{l_w} = \frac{130}{24} = 5.4 > 2$$

$$\alpha_c = 2$$

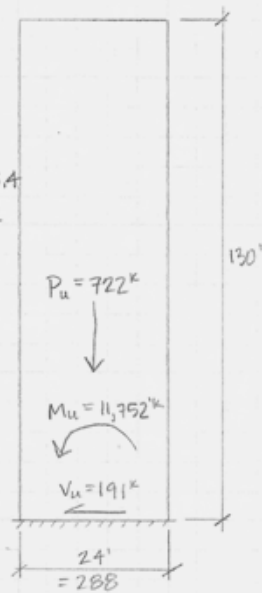

ACI, CH. 21

$$F_y = 60 \text{ ksi}$$

$$f'_c = 5 \text{ ksi}$$

12" THICK

OPENINGS NEGLIGIBLE

$$A_g = 288(12) = 3456 \text{ in}^2$$

$$I_g = \frac{12(288)^3}{12} = 23,887,872 \text{ in}^4$$

$$y = \frac{288}{2} = 144"$$

$$f_c = \frac{722}{3456} \pm \frac{11752(12)(144)}{23,887,872}$$

$$= 0.209 \pm 0.85 = 1.06 > 1 \text{ ksi}$$

 $\therefore$  B.E. REQ'DB.E. DESIGN

$$A_{s, \text{trial}} = \frac{11,752^k}{24' \cdot 60 \text{ ksi}} = 8.17 \text{ in}^2$$

$$(12) \#8 \rightarrow A_s = 9.48 \text{ in}^2, \rho_{st} = \frac{9.48}{22 \times 12} = 0.036 > 0.01 < 0.06 \checkmark \text{ OK}$$

$$C_u = \frac{722}{2} + \frac{11752}{24} = 851^k$$

$$C_u = 851 \leq 0.8(0.65) [0.85(5)(A_g - 9.48) + 60(9.48)]$$

$$\Rightarrow A_g \geq 261 \text{ in}^2 \quad (12" \times 22")$$

#4 TIES

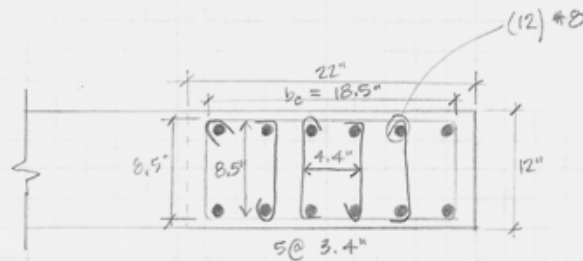

HOOPS

$$S_{max} \leq \frac{1}{4}(12") = 3" \leftarrow \text{USE } 3" \text{ VERT. SPACING}$$

$$6(1") = 6"$$

$$4 + \left(\frac{8.0 - 4.4}{3}\right) = 5.2"$$

$$A_{sh} \geq 0.09(3)(18.5)\left(\frac{5}{60}\right) = 0.416 \text{ in}^2$$

$$0.3(3)(18.5) \left[ \left( \frac{22 \times 12}{18.5 \times 8.5} \right) - 1 \right] \left( \frac{5}{60} \right) = \underline{0.942 \text{ in}^2} \text{ GOVERNS}$$

$$A_{s, prov} = 6(0.2 \text{ in}^2) = 1.2 \text{ in}^2 > 0.942 \text{ in}^2 \therefore \underline{OK}$$

(6) #4 TIES @ 3" VERT. SPACING

TRANSV.  $\frac{1}{3}$  LONG. REINF.

#4 @ 12" EF, EW - CHECK

$$\rho_t = \frac{2(0.2)}{(12)(12)} = 0.00278 > 0.0025 \checkmark \underline{OK}$$

$$\phi V_n = 0.75 \left[ 3456 (2\sqrt{5000} + 0.00278(60000)) \right] / 1000 = 799 \text{ K}$$

$$A_{cv} = 12 \times 24(12) = 3456 \text{ in}^2$$

$$\phi V_n > V_u = 191 \text{ K} \therefore \underline{OK}$$

SW-11 } SW-2  
 } SW-5  
 } CONSERV.  
 } FOR

EXEC.  
 RES. ID. INN

KMR 1/1

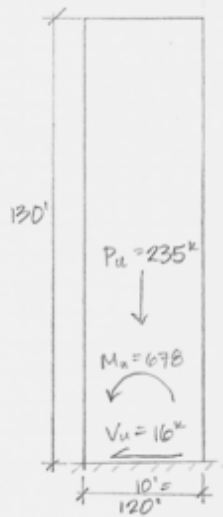

ACI, CH. 21

$F_y = 60 \text{ ksi}$   
 $f'_c = 5 \text{ ksi}$

12" THICK

OPENINGS NEGLECTIBLE

$$A_g = 120 \times (12) = 1440 \text{ in}^2$$

$$I_g = \frac{(12)(120)^3}{12} = 1,728,000 \text{ in}^4$$

$$\bar{y} = \frac{120}{2} = 60 \text{ in}$$

$$f_o = \frac{235}{1440} \pm \frac{678(12)(60)}{1728000}$$

$$= 0.163 \pm 0.283 = 0.45 < 1.0$$

$\therefore$  B.E. NOT REQ'D.

CHORD REINF.

PER PCA WALL  $\rightarrow$

**(S) #8 (A) #5 TIES @ 6" VERT. SPACING.**

TRANSV. & LONG.

**#4 @ 12" EF, EW**

$$\rho_t = 0.00278$$

$$A_{cv} = 12(10 \times 12) = 1440$$

$$\phi V_n = 0.75 [1440 (2\sqrt{5000} + 0.00278(60000))] / 1000 = 333 \text{ k}$$

$$\phi V_n > V_u = 235 \text{ k} \therefore \underline{\underline{OK}}$$

SW-7

EXEC.  
RESID. INN

KMR

1/1

(SAME AS SW-11, EXCEPT CHORDS MORE CRIT B/C SHORTER WIDTH)  
9' WIDTH, B.E.'S NOT REQ'D.

CHORD REINF.

PER PCA WALL → (10) #8 ; (4) #5 TIES @ 6" VERT. SPACING

TRANSV. &amp; LDNG. #4 @ 12" EF, EW

$$\rho_t = 0.00278$$

$$A_{cv} = 12(9 \times 12) = 1296 \text{ in}^2$$

$$\phi V_n = 0.75 [1296 (2\sqrt{5000}) + 0.00278(60000)] / 1000 = 300 \text{ k}$$

$$\phi V_n > V_u = 12 \text{ k} \therefore \underline{\text{OK}}$$

$$\frac{h_w}{l_w} = \frac{130}{25.5} = 5.1$$

$$> 2 \therefore \alpha_c = 2$$

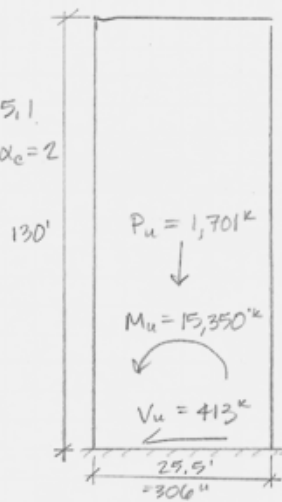

ACI, CH. 21:

$$F_y = 60 \text{ ksi}$$

$$f'_c = 5 \text{ ksi}$$

12" THICK

OPEN. NEG.

$$A_g = 306(12) = 3672 \text{ in}^2$$

$$I_g = \frac{12(306)^3}{12} = 28,652,616 \text{ in}^4$$

$$\bar{y} = 306/2 = 153"$$

$$f_c = \frac{1701}{3672} \pm \frac{15350(12)(153)}{28652616}$$

$$= 0.463 \pm 0.984 = 1.45 > 1.0$$

 $\therefore$  B.E.'S REQ'DB.E. DESIGN

$$A_{s, \text{trial}} = \frac{15350}{\frac{25.5'}{60 \text{ ksi}}} = 10.0 \text{ in}^2$$

$$(14) \#8 \rightarrow A_s = 11.06 \text{ in}^2, \rho_{st} = \frac{11.06}{30 \times 18} = 0.02 < 0.06 \quad \checkmark \text{OK}$$

$$C_u = \frac{1701}{2} + \frac{15350}{25.5} = 1453 \text{ k}$$

$$C_u = 1453 \leq 0.8(0.65) [0.85(5)(A_g - 11.06) + 60(11.06)]$$

$$\Rightarrow A_g \geq 513 \text{ in}^2 \sim 18" \times 30"$$

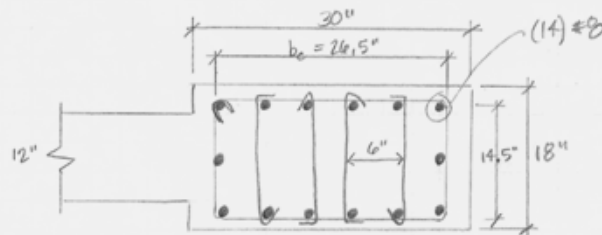
COVER = 1.5"  
SPACING = 5"  
#4 TIES



HOOPS

$$s_{max} \leq \frac{1}{4}(18") = 4.5" \leftarrow \text{GOVERNS, USE 4" SPACING}$$

$$6(1") = 6"$$

$$4 + \left( \frac{14 - 6}{3} \right) = 6.67"$$

$$A_{sh} \geq 0.09(4)(26.5) \left( \frac{5}{60} \right) = 0.795 \text{ in}^2$$

$$0.3(4)(26.5) \left[ \left( \frac{30 \times 18}{26.5 \times 14.5} \right) - 1 \right] \left( \frac{5}{60} \right) = \underline{1.07 \text{ in}^2} \text{ GOVERNS}$$

$$A_{s, \text{prov}} = 6(0.2 \text{ in}^2) = 1.2 \text{ in}^2 > 1.07 \text{ in}^2 \therefore \underline{\text{OK}}$$

(6) #4 TIES @ 4" VERT SPACING

TRANSV. & LONG. REINF.

#4 @ 12" EF, EW - CHECK

$$\rho_t = 0.00278$$

$$A_{cv} = 3672 \text{ in}^2$$

$$\phi V_n = 0.75 [3672 (2\sqrt{5000} + 0.00278(60000))] / 1000 = 849 \text{ k}$$

$$\phi V_n > V_u = 413 \text{ k} \therefore \underline{\text{OK}}$$

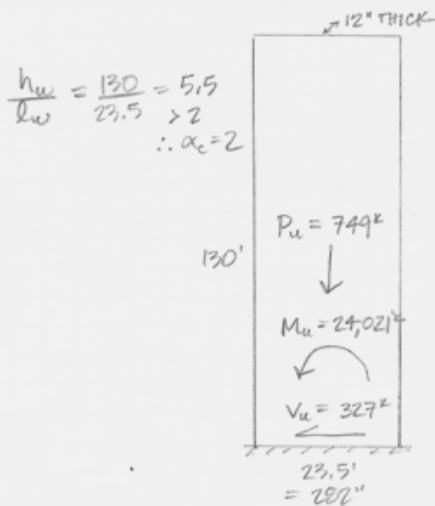

$$A_g = 282(12) = 3384 \text{ in}^2$$

$$I_g = \frac{12(282)^3}{12} = 22,257,688 \text{ in}^4$$

$$\bar{y} = 282/2 = 141"$$

$$f_c = \frac{749}{3384} \pm \frac{24021(12)(141)}{22,257,688} =$$

$$0.22 \pm 1.81 = 2.03 > 1.0$$

B.E.'S REQ'D

### B.E. DESIGN

$$A_{s, \text{min}} = \frac{24021}{\frac{23.5}{60}} = 17.04 \text{ in}^2$$

$$(14) \#10 \rightarrow A_s = 17.8 \text{ in}^2 ; f_{st} = \frac{17.8}{34 \times 12} = 0.044 > 0.01 < 0.06 \checkmark$$

$$C_u = \frac{749}{2} + \frac{24021}{23.5} = 1397^k$$

$$1397^k \leq 0.8(0.65) [0.85(5)(A_g - 17.8) + 60(17.8)]$$

$$\Rightarrow A_g \geq 398 \text{ in}^2 \sim 12" \times 34"$$

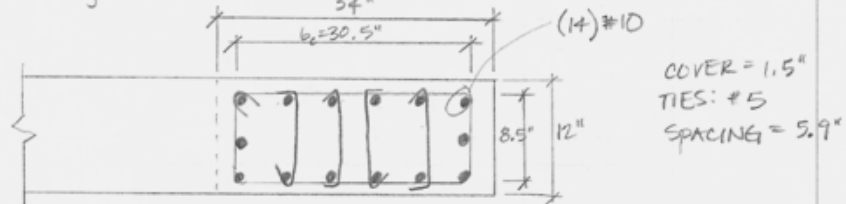

### HOOPS

$$s_{\text{max}} \leq \frac{1}{4}(12") = 3" \leftarrow \text{GOVERNS}$$

$$6(1.27") = 7.62"$$

$$4 + \left(\frac{14 - 5.9}{3}\right) = 6.7"$$

(6) #5 TIES @ 3" VERT. SPACING

$$A_{sh} \geq 0.09(3)(30.5) \left(\frac{5}{60}\right) = 0.69 \text{ in}^2$$

$$0.3(3)(30.5) \left[\frac{34 \times 12}{30.5 \times 8.5} - 1\right] \left(\frac{5}{60}\right) = 1.31 \text{ in}^2$$

$$A_{s, \text{prov}} = 6(0.31 \text{ in}^2) = 1.86 \text{ in}^2 > 1.31 \text{ in}^2 \therefore \text{OK}$$

	SW-12	EXEC. RESID - INN	KMR	2/2
	<p><u>TRANSV. <math>\frac{1}{2}</math> LONG. REINF.</u></p> <p>#4@ 12" EF, EW - CHECK</p> <p><math>\rho_t = 0.00278</math></p> <p><math>\phi V_n = 0.75 [3384 (2\sqrt{5000}) + 0.00278 (60000)] / 1000 = 782^k</math></p> <p><math>\phi V_n &gt; V_u = 327^k \therefore \underline{OK}</math></p>			

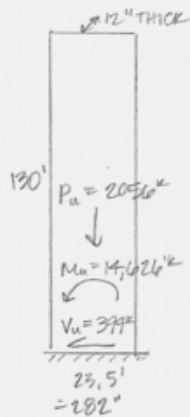

$$A_g = 12(282) = 3384 \text{ in}^2$$

$$I_g = 22,425,768 \text{ in}^4$$

$$\bar{y} = 141''$$

BY INSPECT, B.E.'S REQ'D  
TRANSV. & LONG. REINF.

#4 @ 12" EF, EW

$$\phi V_n = 782 \text{ k} > V_u = 399 \text{ k} \therefore \text{OK}$$

### B.E. DESIGN

$$A_s = \frac{14626}{\frac{23.5}{60}} = 10.2 \text{ in}^2$$

$$(14) \#8 \rightarrow A_s = 11.06 \text{ in}^2$$

$$C_u = \frac{2056}{2} + \frac{14626}{23.5} = 1650 \text{ k}$$

$$1650 \leq 0.8(0.65) [0.85(5)(A_g - 11.06) + 60(11.06)]$$

$$\rightarrow A_g \geq 602 \text{ in}^2 \sim 18'' \times 34''$$

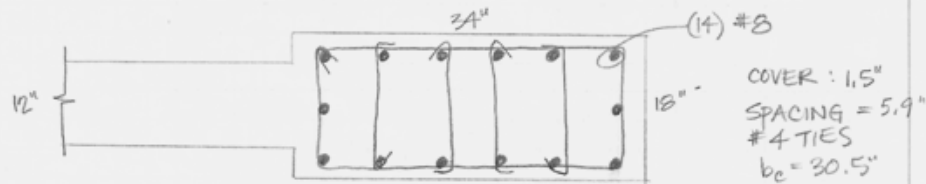

### HCOPS

$$S_{max} \leftarrow \frac{1}{4}(18'') = 4.5'' \leftarrow \text{USE } 4'' \text{ SPACING}$$

$$6(1'') = 6''$$

$$4 + \left(\frac{14 - 6}{2}\right) = 6.67''$$

$$A_{sh} \geq 0.09(4)(30.5) \left(\frac{5}{60}\right) = 0.92 \text{ in}^2$$

$$0.3(4)(30.5) \left[ \frac{(34 \times 18)}{(30.5 \times 14.5)} - 1 \right] \left(\frac{5}{60}\right) = 1.17 \text{ in}^2$$

$$A_{s,prov.} = 6(0.2) = 1.2 > 1.17 \therefore \text{OK}$$

(6) #4 TIES @ 4" VERT SPACING

SW-14, SW-8  
CONSERV.  
FOR

EXEC.  
RESID. INN

KMR 1/1

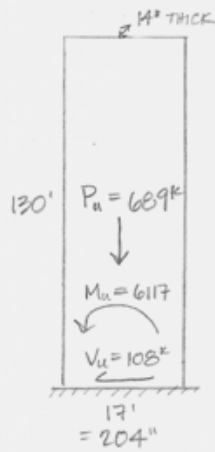

$$A_g = 14(204) = 2856 \text{ in}^2$$

$$I_g = 9,904,608 \text{ in}^4$$

$$\bar{y} = 102''$$

$$f_c = \frac{689}{2856} \pm \frac{6117(12)(102)}{9904608}$$

$$= 0.24 \pm 0.75 = 0.99 < 1.0$$

$\therefore$  BE'S  
NOT REQ'D

CHORD REINF.

PER PCA WALL  $\rightarrow$  (14) #10 ; (5) #4 TIES @ 6" VERT. SPACING

TRANSV. & LONGI. REINF.

#4 @ 12" EF, EW

$$\rho_t = 0.00278$$

$$A_{cv} = 2856$$

$$\phi V_n = 660^k > V_u = 108^k \therefore \text{OK}$$

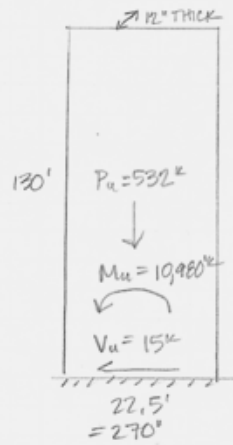

$$A_g = 12(270) = 3240 \text{ in}^2$$

$$I_g = 19,683,000 \text{ in}^4$$

$$\bar{y} = 135"$$

$$f_c = \frac{532}{3240} \pm \frac{10980(12)(135)}{19683000} = 1.07 > 1.0$$

$\therefore$  B.E.'s  
REQ'D

### B.E. DESIGN

$$A_c = \frac{10980}{\frac{22.5}{60}} = 8.13 \text{ in}^2$$

$$(12) \#8 \rightarrow A_s = 9.48 \text{ in}^2$$

$$C_u = \frac{532}{2} + \frac{10980}{22.5} = 754 \text{ k}$$

$$754 \leq 0.2(0.65) [0.85(5)(A_g - 9.48) + 60(9.48)]$$

$$\Rightarrow A_g \geq 217 \text{ in}^2 \sim 12" \times 20"$$

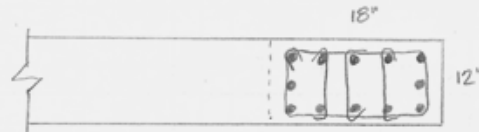

1.5" COVER  
#4 TIES  
 $b_c = 14.5"$   
Spacing = 3.4"

### HOOPS

$$S_{max} \leq \frac{1}{4}(12) = 3" \leftarrow \text{By INSPECT., WILL GOVERN}$$

$$A_{sh} \geq 0.3(3)(14.5) \left[ \frac{18 \times 12}{14.5 \times 8.5} - 1 \right] \left( \frac{5}{60} \right) = 0.82 \text{ in}^2$$

$$A_{s,prov} = 5(0.2) = 1.0 \text{ in}^2 > 0.82 \text{ in}^2 \therefore \text{OK}$$

(5) #4 TIES @ 3" VERT. SPACING

TRANSV. & LONG. REINF. #4 @ 12" EF, EW

$$\phi V_n = 749 > V_u = 15 \text{ k} \therefore \text{OK}$$

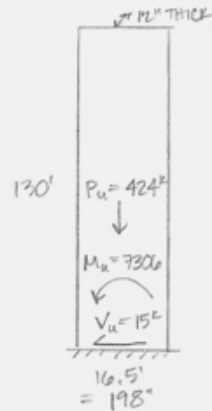

$$A_g = 2376 \text{ in}^2$$

$$I_g = 7,762,392 \text{ in}^4$$

$$\bar{y} = 99 \text{ in.}$$

$$f_c = \frac{424}{2376} \pm \frac{7306(12)(99)}{7,762,392} = 1.3 > 1.0$$

$\therefore$  B.E.'S REQ'D

### B.E. DESIGN

$$A_s = \frac{7306}{\frac{16.5}{60}} = 7.4 \text{ in}^2$$

$$(10) \#8 \rightarrow A_s = 7.9 \text{ in}^2$$

$$C_u = \frac{424}{2} + \frac{7306}{16.5} = 655 \text{ k}$$

$$\Rightarrow A_{g, \text{req'd}} = 193 \text{ in}^2 \sim 12" \times 18"$$

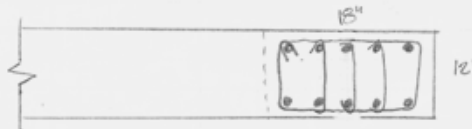

1.5" COVER  
#4 TIES  
 $b_c = 14.5"$   
Spacing = 3.4"

### HOOPS:

$$s_{\text{max}} \leq \frac{1}{4}(12") = 3" \leftarrow \text{BY INSPECT, WILL GOVERN}$$

$$A_{sh} \geq 0.3(3)(14.5) \left[ \frac{18 \times 12}{14.5 \times 8.5} - 1 \right] \left( \frac{5}{60} \right) = 0.82 \text{ in}^2$$

$$A_{sh, \text{prov}} = 5(0.2) = 1.0 \text{ in}^2 > 0.82 \text{ in}^2 \therefore \underline{\text{OK}}$$

(5) #4 TIES @ 3" VERT. SPACING

TRANSV. & LONG. REINF. #4 @ 12" EF, EW

$$\phi V_n = 549 \text{ k} \gg V_u = 15 \text{ k} \therefore \underline{\text{OK}}$$

SHEAR WALL RE-DESIGN COST ANALYSIS

X-Dir.	Material Increases & Associated Costs									
	Concrete			Chord Reinforcement			Chord Ties			
	Shear Wall	Conc. (CY)	\$/CY	\$ Total - Conc.	Chord Reinf. (TONS)	\$/TON	\$ Total - Chord Reinf.	Ties (LF ea. set)	Ties (TONS)	\$/TON
SW-2	0	\$111	\$0	0	\$1,830	\$0	8	1.48	\$1,950	\$2,886
SW-4	32	\$111	\$3,552	1.88	\$1,830	\$3,440	10	1.84	\$1,950	\$3,588
SW-5	0	\$111	\$0	0.82	\$1,830	\$1,501	8	1.08	\$1,950	\$2,106
SW-7	0	\$111	\$0	0.7	\$1,830	\$1,281	8	1.48	\$1,950	\$2,886
SW-9	11.2	\$111	\$1,243	3	\$1,830	\$5,490	10	2.06	\$1,950	\$4,017
SW-11	0	\$111	\$0	1.18	\$1,830	\$2,159	8	1.48	\$1,950	\$2,886
SW-13	0	\$111	\$0	0.7	\$1,830	\$1,281	10	2.6	\$1,950	\$5,070
										<b>TOTAL COST INCREASE</b>
			<b>\$4,795</b>	8	<b>\$15,152</b>	12	<b>\$23,439</b>	<b>\$43,387</b>		



Y-Dir.	Material Increases & Associated Costs									
	Concrete			Chord Reinforcement			Chord Ties			
Shear Wall	Conc. (CY)	\$/CY	\$ Total - Conc.	Chord Reinf. (TONS)	\$/TON	\$ Total - Chord Reinf.	Ties (LF ea. set)	Ties (TONS)	\$/TON	\$ Total - Ties
SW-3	0	\$111	\$0	2.57	\$1,830	\$4,703	8	2.08	\$1,950	\$4,056
SW-1	12	\$111	\$1,332	0.38	\$1,830	\$695	10	1.74	\$1,950	\$3,393
SW-6	13.6	\$111	\$1,510	1.39	\$1,830	\$2,544	10	1.74	\$1,950	\$3,393
SW-8	0	\$111	\$0	1.12	\$1,830	\$2,050	8	0.7	\$1,950	\$1,365
SW-14	0	\$111	\$0	1.12	\$1,830	\$2,050	8	0.7	\$1,950	\$1,365
SW-12	0	\$111	\$0	3.67	\$1,830	\$6,716	10	4.56	\$1,950	\$8,892
SW-10	0	\$111	\$0	0	\$1,830	\$0	8	2.08	\$1,950	\$4,056
			<b>\$2,842</b>	10		<b>\$18,758</b>	14		<b>\$26,520</b>	<b>\$48,119</b>